

BELLITALIA



CONTEMPORARY ARCHITECTURE



INSPIRED BY
TIMELESS BEAUTY

INDEX PRODUCTS

	BENCHES PANCHE BANCOS BANCS	136	ORGANIC COLLECTION
244	ALBA	138	CUDDL
246	APOLLO	144	FAMILY
36	ARROW	142	FUNNY
104	BRAIES COLLECTION	140	HAPPY
162	CLIP	146	HARMONY
44	DEMETRA COLLECTION	188	RETTA
48	DEMETRA BENCHES	200	RING - RING REVERSE COLLECTION
168	DNA	250	ROGER
114	DOLOMITI	74	SHAOLIN COLLECTION
28	JONATHAN	260	SPRING
174	KUBB COLLECTION	208	VENEZIA - ERACLEA COLLECTION
176	KUBB BENCHES	216	ERACLEA
152	LABYRINTH COLLECTION	220	ERACLEA BACK
154	ATE	230	ERACLEA GRES
154	EOS	224	ERACLEA WOOD
156	IDRA	234	VENEZIA BABY&OLD
154	IRIS	232	VENEZIA - VENEZIA WOOD
64	LIDÒ COLLECTION	90	WING COLLECTION
82	LOUNGE COLLECTION	92	WING UTC
192	OLIMPO COLLECTION	98	WING WOOD
194	OLIMPO		GAMES GIOCHI JUEGOS JEUX
198	OLIMPO S	262	
120	ONDA COLLECTION	278	LAVAGNA
124	ONDA BENCHES	268	PINGPONG
		274	SCACCHI

264 TEQBALL

TABLES TAVOLI
MESAS TABLES

238 AURORA

208 VENEZIA - ERACLEA COLLECTION

210 ERACLEA TABLE

152 LABYRINTH COLLECTION

156 REA

PLANTERS FIORIERE
JARDINERAS JARDINIÈRES

152 LABYRINTH COLLECTION

156 ATE F

322 BERRY

332 CASSIOPEA

302 CLIMB

328 COROLLA

324 CORVARA

44 DEMETRA COLLECTION

54 DEMETRA PLANTERS

174 KUBB COLLECTION

180 KUBB PLANTERS

64 LIDÒ COLLECTION

316 LONG - SHORT

192 OLIMPO COLLECTION

194 OLIMPO

198 OLIMPO S

120 ONDA COLLECTION

128 ONDA PLANTERS

314 ORIONE - PEGASO

280 PIANETI COLLECTION

284 GIOVE

284 LUNA

284 MARTE

284 SATURNO

284 VENERE

292 PIANETI WITH MURANO GLASS

200 RING - RING REVERSE COLLECTION

310 TALL - LOW

**LITTER BINS & CIGARETTE
BINS** CESTINI & SIGARETTE
PAPELERAS & CENICERO
CORBELLES & CENDRIERS

370

382 INTERSECTION

386 ORIONE SC - CC

388 PEGASO SC - CC

378 QU

372 ROLLE

390 SQUARE

376 TRI

BOLLARDS DISSUASORI
BOLARDOS BORNES

350

352 BOSTON

358 DENZ

INDEX PRODUCTS

152 LABYRINTH COLLECTION

154 IDRA

354 KONE - TRONCO

356 NY

364 OBELIX

362 PLUTONE

360 SFERA

DISPLAY STANDS BACHECHE
EXPOSITORES AFFICHAGES

392 TOTÒ

CYCLE RACKS
PORTABICICLETTE
APARCABICIS PORTE-VÉLOS

356 NY AP

356 T-BIKE - T-BOX

368 UP DOWN

TREE GRILLS GRIGLIE PER
ALBERI ALCORQUES GRILLES
D'ARBRES

336

342 BUBBLE - BUBBLE SQUARE

340 CIRCLE

344 DIAGO

338 SOLAR - SOLAR SQUARE

RECYCLING POINT
ISOLA ECOLOGICA ISLA
ECOLÓGICA ÎLE ÉCOLOGIQUE

412 RETROSCENA

SHELTERS PENSILINE
MARQUESINAS ABRIS

422 MAGNUM EVOLUTION L

418 MAGNUM EVOLUTION S

CONCRETE SLABS LASTRE DI
CEMENTO LOSAS DE CONCRETO
DALLES DE BÉTON

396

BELLITALIA



Bellitalia® è il produttore globale di soluzioni di arredo urbano e paesaggistico in calcestruzzo. Nasce negli anni '60, e presto diviene leader nel settore: le continue sfide permettono all'azienda di evolversi costantemente e di raggiungere in breve tempo una diffusione capillare. Numerosi prodotti dell'azienda sono diventati iconici e possono essere trovati in oltre 30 Paesi nel mondo, in alcune delle piazze, parchi, musei, campus universitari più rinomati.

Bellitalia® fa parte di THE PLACEMAKERS, gruppo che riunisce differenti aziende e brand, impegnati a studiare bisogni emergenti per anticipare tendenze future, producendo arredi per trasformare gli spazi in luoghi dedicati alle persone, che stimolino la socialità, la connessione interpersonale ed il benessere, sia in contesti urbani che privati.

BELLITALIA®

Bellitalia® is a global manufacturer of street and park furniture in concrete. Founded in the '60s, it soon became a leader in the industry: continuous challenges have allowed the company to constantly evolve and to quickly develop a widespread distribution. Many of the company's products have become iconic and can be found in more than 30 countries around the world, in some of the most renowned squares, piazzas, parks, museums, and university campuses.

Bellitalia® is part of THE PLACEMAKERS, a group that brings together different companies and brands committed to studying emerging needs in order to anticipate future trends, manufacturing furniture to create spaces dedicated to people, which stimulate social interaction, interpersonal connection and well being, both in urban and private settings.

In Bellitalia® progettiamo i nostri prodotti ispirandoci ad un concetto di bellezza senza tempo: non ci leghiamo alle mode passeggere, ma ricerchiamo canoni di bellezza estetici ed universalmente apprezzabili per un design che duri nel tempo, proprio come i nostri prodotti in calcestruzzo. Se bellezza e design sono per noi senza tempo, la tecnica invece richiede innovazione. Per questo, da oltre 50 anni, non smettiamo di innovare i nostri materiali per raggiungere livelli di prestazioni piu elevate a fronte di maggiore sostenibilità. Proprio a tal fine è nato ATOMS, il nostro laboratorio di ricerca e sviluppo, costantemente focalizzato nell'innovazione del calcestruzzo e delle sue tecniche produttive.

INSPIRED BY TIMELESS BEAUTY

At Bellitalia®, our products are designed with a sense of timeless beauty: we do not follow passing fads, but seek aesthetic and universally appreciated beauty standards for a design that lasts over time, just like our concrete products. While design and beauty are timeless for us, technology instead requires innovation. This is why, for more than 50 years we have not stopped innovating our materials to achieve higher levels of performance to face an higher sustainability of our processes, and for this reason ATOMS was founded, our research and development laboratory, constantly focused on concrete mixtures' and productive techniques' innovation.

BE

INSPI

A red perforated metal wall with a mountain background. The wall is made of a grid of red metal bars with small holes. In the background, there is a large, green, forested mountain range under a cloudy sky. The word "ELLITALIA" is written in large, white, sans-serif capital letters across the middle of the wall. Below it, a dark grey horizontal band contains the text "RED BY TIMELESS BEAUTY" in a lighter, sans-serif font.

ELLITALIA

RED BY TIMELESS BEAUTY



ABBRACCIARE CONCRETAMENTE LO SPAZIO

La trasformazione di uno spazio in un luogo iconico di stile ed eleganza può avvenire solo se si analizza lo spazio dalle diverse prospettive da cui lo vedranno un giorno le persone. Bisogna saper mettere in equilibrio i luoghi con i paesaggi che li circondano e con i contesti culturali nei quali sono immersi. Utilizziamo il calcestruzzo proprio perchè è un materiale resistente e versatile, modellabile a seconda delle storie che si vogliono raccontare. Le nostre miscele offrono una maggiore scelta di finiture, materiali e aggregati, per rendere ogni progetto unico e personale.



EMBRACING THE SPACE CONCRETELY

Transforming a space into an iconic place of style and elegance can only happen if the space is analyzed from the different perspectives of the people who will one day see it.

It is necessary to know how to balance places with the landscapes that surround them and with the cultural contexts in which they are immersed. We use concrete precisely because it is a moldable material that changes according to the stories that need to be told.

Our mixtures offer a greater choice of finishes, materials and aggregates to make each project unique and personal.



BREAKING THE MOLD

Basing on more than 50 years of experience we have developed a mixture called Reconstituted Precious Stones which brings together the beauty of natural stone and the technical characteristics of concrete.

Reconstituted Precious Stones offer, thanks to the multiple kind of natural interts, different colours and finishes adaptable to any kind of project.

In addition, thanks to innovative manufacturing techniques, we have patented two different cement mixtures: UTC® that allows to create increasingly complex and subtle shapes, overcoming the previous physical limitations of concrete, and HTC that allows to achieve a smooth formwork finish without further processing.

ROMPERE GLI SCHEMI

Grazie ai nostri 50 anni di esperienza abbiamo sviluppato una miscela chiamata Pietre Preziose Ricostituite che riunisce la bellezza della pietra naturale con le caratteristiche tecniche del calcestruzzo offrendo, grazie alle molteplici varianti di inerti naturali, diverse colorazioni e finiture per adattarsi ad ogni progetto.

Inoltre, grazie ad innovative tecniche di produzione e alla collaborazione con il laboratorio ATOMS abbiamo brevettato due miscele cementizie innovative: UTC[®], che permette di creare forme sempre più complesse e sottili, superando i precedenti limiti fisici del calcestruzzo e l'HTC che ci consente di ottenere una finitura liscio cassero senza ulteriori lavorazioni.



CEMENTARE L'IMPEGNO CON LA SOSTENIBILITÀ

In quanto parte del gruppo The Placemakers, aspiriamo a trasformare gli spazi urbani in luoghi di vita confortevoli, sicuri, inclusivi e più sostenibili per le persone e per l'ambiente.

Da anni ormai, il nostro impegno concreto consiste nell'attuare buone pratiche di progettazione dei nostri prodotti perché siano durevoli, ma anche riciclabili a fine vita, di scegliere ed utilizzare responsabilmente ed efficientemente i materiali che li compongono e di innovare sempre di più i processi produttivi per ridurre l'impatto.

Grazie ad un R&D sempre attento alle esigenze emergenti, ad una produzione in continua evoluzione e al supporto del laboratorio di ricerca e innovazione ATOMS, non ci stanchiamo di rendere la nostra crescita ogni giorno più sostenibile.



A CONCRETE ENGAGEMENT TO SUSTAINABILITY

As part of The Placemakers Group, we aspire to transform urban spaces into comfortable, safe, inclusive and more sustainable living places for people and the environment.

For years now, our concrete commitment has been to implement good practices in the design of our products so that they are durable, but also recyclable at the end of their life, to choose and use the materials that make them up responsibly and efficiently, and to increasingly innovate the production processes in order to reduce their impact.

Thanks to R&D that is always attentive to emerging needs, a constantly evolving production, and the support of the ATOMS research and innovation laboratory, we never tire of making our growth more sustainable every day.

PRODOTTI PENSATI PER DURARE E PER ESSERE REINVENTATI

Crediamo che le cose migliori dovrebbero esistere più a lungo, anche se nulla dura per sempre. Per questo concepiamo e produciamo i nostri prodotti perché siano durevoli nel tempo, ma anche perché consentano un riciclo professionale al termine del loro ciclo di vita.

A tal fine, tutti i nostri prodotti in Pietre Preziose Ricostituite, HTC e UTC non contengono resine. Inoltre, scegliamo materiali riciclabili e progettiamo i nostri prodotti perché i diversi componenti e materiali, possano essere facilmente smontati e divisi per consentirne il riciclo.



PRODUCTS THAT ARE MEANT TO LAST AND TO BE REINVENTED

We believe that the best things should exist for a long time, even if nothing lasts forever. This is why we design and manufacture our products to last over time, but also to be recycled at the end of their life cycle. To this end, all our Reconstituted Precious Stones, HTC and UTC products do not contain resins. Furthermore, we choose recyclable materials and design our products so that the different components and materials can be easily disassembled and separated for recycling.

SCELTE ACCURATE E USO SAPIENTE DI PREZIOSE MATERIE PRIME

Siamo consapevoli del valore delle materie prime che ci consentono di creare i nostri prodotti, le selezioniamo e approvvigioniamo con cura per poi utilizzarle attentamente. Selezioniamo esclusivamente i fornitori che condividono i nostri valori ambientali e sociali e che assicurano un determinato livello di qualità.

Per ridurre ulteriormente l'impatto ambientale degli approvvigionamenti privilegiamo i fornitori a noi più vicini.

Ad esempio, i frammenti di marmo utilizzati nelle nostre Pietre Preziose Ricostituite provengono tutti da cave italiane, compresa l'area di Carrara.

Ricerchiamo la funzionalità e la durabilità, evitando però inutili eccessi: a tal fine, calcoliamo lo spessore dei diversi materiali in modo che siano performanti, ma senza sprechi.

Infine, i residui prodotti durante il nostro processo di produzione vengono raccolti per essere riciclati o riutilizzati.



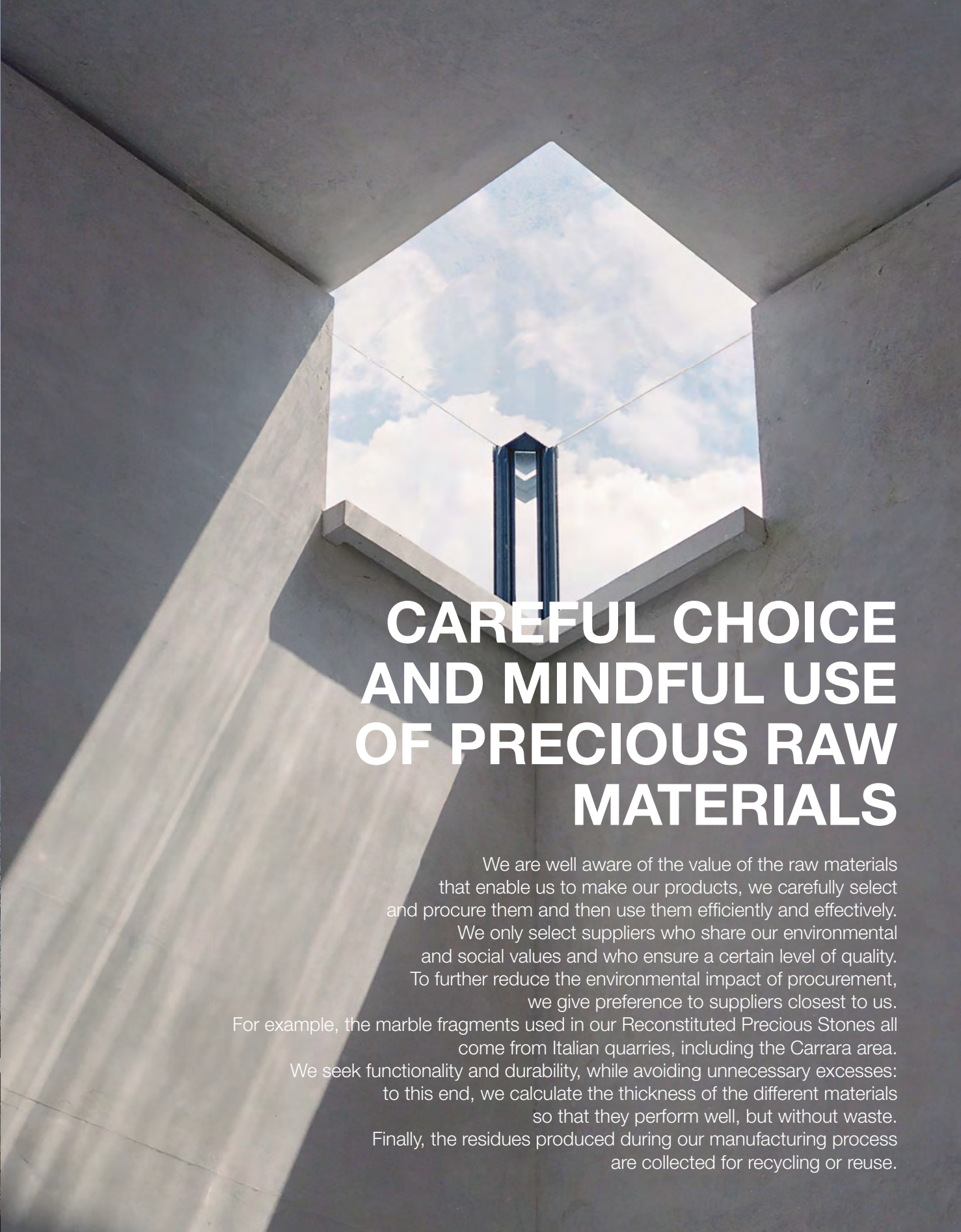

CAREFUL CHOICE AND MINDFUL USE OF PRECIOUS RAW MATERIALS

We are well aware of the value of the raw materials that enable us to make our products, we carefully select and procure them and then use them efficiently and effectively.

We only select suppliers who share our environmental and social values and who ensure a certain level of quality.

To further reduce the environmental impact of procurement, we give preference to suppliers closest to us.

For example, the marble fragments used in our Reconstituted Precious Stones all come from Italian quarries, including the Carrara area.

We seek functionality and durability, while avoiding unnecessary excesses: to this end, we calculate the thickness of the different materials so that they perform well, but without waste.

Finally, the residues produced during our manufacturing process are collected for recycling or reuse.



PRODURRE A BASSO IMPATTO

Utilizziamo per la nostra produzione solo energia certificata sostenibile al 100% e da sempre crediamo e investiamo in fonti di energia rinnovabile.

I tetti degli stabilimenti del gruppo The Placemakers, di cui Bellitalia fa parte, ospitano oltre 7500 pannelli solari, grazie ai quali si previene l'emissione in atmosfera di circa 850 tonnellate di CO₂, corrispondenti a circa 340 tonnellate di petrolio equivalente. Non ci basta utilizzare energia pulita, ci impegniamo costantemente per ridurre il più possibile i consumi attraverso una ricerca costante che ci porta ad innovare processi produttivi e materiali.

Ad esempio, grazie alle tecniche innovative di lavorazione di UTC® ed HTC, che non necessitano di vibrazione, riduciamo le operazioni di finitura dei prodotti, rendendo il processo meno energivoro e più sostenibile.

Inoltre, per l'acqua necessaria al nostro processo produttivo abbiamo implementato un sistema a "ciclo chiuso", che ne permette la raccolta e il riutilizzo, al fine di evitare sprechi. La sostenibilità, però, non è solo una questione di provenienza ed utilizzo dell'energia e delle risorse.

Richiede anche una scelta di processi più responsabili e meno inquinanti, per questo non rifiniamo i nostri prodotti attraverso acid etching e le vernici protettive del cemento e del legno da noi utilizzate sono a base d'acqua.

PRODUCING AT LOW IMPACT

We only use 100% certified sustainable energy for our production and we have always believed and invested in renewable energy sources.

The roofs of the factories of The Placemakers Group, to which Bellitalia belongs, house more than 7500 solar panels, which allows us to prevent more than 850 tons of CO₂, corresponding to about 340 tons of oil equivalent, to be emitted into the atmosphere.

It is not enough for us to use clean energy, we constantly strive to reduce consumption as much as possible through constant research that leads us to innovate production processes and materials.

For example, with UTC® and HTC's innovative vibration-free processing techniques, we are able to reduce the finishing operations of the products, making the process less energy-intensive and more sustainable.

Furthermore, we have implemented a "closed loop" system for the water needed to run the production process, which allows it to be collected and reused in order to reduce waste and promote water conservation.

Sustainability, however, is not just a matter of sourcing and using energy and resources.

It also requires choosing more responsible and less polluting processes, which is why we do not refinish our products with acid etching, and the protective paints we use for the cement and wood are water based.

A young green plant with several leaves is growing from the ground. The background is a blurred forest floor with fallen leaves and soil. The text is overlaid on the left side of the image.

**LA SOSTENIBILITÀ
NON È UNO SLOGAN
O UNA CAMPAGNA
DI MARKETING.
È UNA SCELTA.
È CIÒ CHE FAI GIORNO
DOPO GIORNO,
QUANDO NESSUNO
STA GUARDANDO.**



**SUSTAINABILITY
IS NOT A CLAIM OR
A MARKETING CAMPAIGN.
IT'S A CHOICE.
IT'S WHAT YOU DO DAY IN
AND DAY OUT,
WHEN NO ONE ELSE IS LOOKING.**

THE PLACEMAKERS
Making Spaces Living Places

TOP

FINISHING ON THE SEATING SURFACE

FINITURA SUL PIANO DI SEDUTA

ACABADO DE LA SUPERFICIE DEL ASIENTO

FINITION SUR L'ASSISE

SIDE

FINISHING ON SIDES

FINITURA LATERALE

ACABADO LATERAL

FINITION LATÉRALE

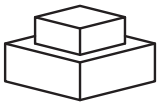

FOUNDATION PLINTH

PLINTO DI FONDAZIONE

PLINTO DE FUNDICIÓN

SOCLE DE FONDATION



MATTE

MATTE PAINT



FRAME

CONTROTELAIO

MARCO

SOUS-CHÂSSIS



GLOSSY

GLOSSY PAINT



EYEBOLT

GOLFARE

CÁNCAMO

ANNEAU À TIGE



BENCH

PANCA

BANCO

BANC

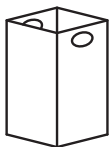

INNER CONTAINER

CONTENITORE INTERNO

CONTENEDOR INTERNO

RÉCIPIENT INTÉRIEUR



ASHTRAY

POSASCENERE

CENICERO

CENDRIER



PERIMETRAL PLATES

PIASTRE PERIMETRALI

PLACAS PERIMETRALES

PLAQUES DU PÉRIMÈTRE



THREADED BARS

BARRE FILETTATE

VARILLAS ROSCADAS

TIGES FILETÉES

LEGEND



WITH BUSH-HAMMERING
CON BOCCIARDATURA
CON ABUJARDADO
AVEC BOUCHARDAGE

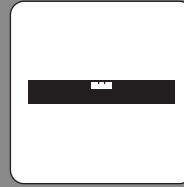

WITH LEVELING SYSTEM
CON LIVELLAMENTO
CON NIVELACIÓN
AVEC NIVELLEMENT



POLISHED

WITH POLISHING
CON LEVIGATURA
CON PULIDO
AVEC LISSAGE



WITH ANTIDECAY
CON ANTIDEGRADO
CON ANTIDEGRADACIÓN
AVEC ANTI DÉGRADATION

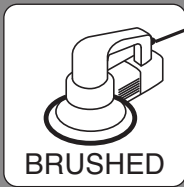

BRUSHED

WITH BRUSHING
CON SPAZZOLATURA
CON TRABAJO CON PUAS RIGIDAS
AVEC BROSSAGE



WITH ANTI-GRAFFITI
CON ANTI-GRAFFITI
CON ANTI-GRAFITI
AVEC ANTI-GRAFFITI

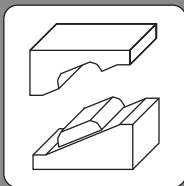

SMOOTH FORMWORK
LISCIO CASSERO
LISO
LISSE



WITH LED LIGHT
CON LUCE LED
CON LUZ LED
AVEC LED

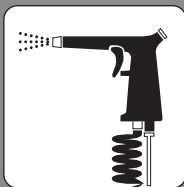

WITH SANDBLASTING
CON SABBIATURA
CON CHORRO DE ARENA
AVEC SABLAGE

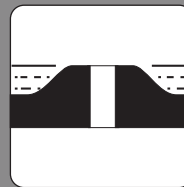

OVERFLOW DRAINAGE
SCARICO TROPPO PIENO
DESAGÜE REBOSADERO
SYSTÈME DE TROP-PLEIN



INOX

STAINLESS STEEL
ACCIAIO INOX
ACERO INOX
ACIER INOX



RAL

POWDER COATED STEEL
ACCIAIO VERNICIATO
ACERO PINTADO
ACIER THERMOLAQUÉ

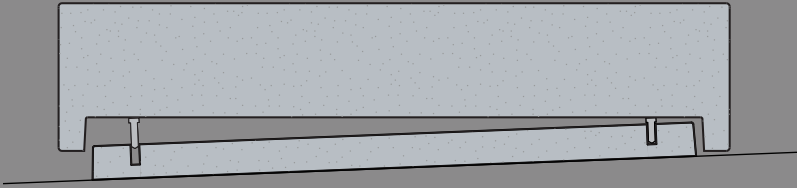

Bench with levelling system
Panca con sistema di livellamento
Banco con sistema de nivellación
Banc avec système de nivellage



Bench with bottom narrowing
Panca con scuretto
Banco con base
Banc avec rétrécissement de la base

BASIC INFO

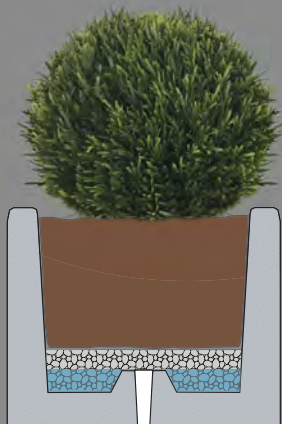

Planter with water stock and overflow drainage
Fioriera con riserva d'acqua e troppo pieno
Jardiniera con reserva de agua y desagüe revosaguero
Jardinière avec réserve d'eau et système de trop-plein



Planter with water drainage
Fioriera con scarico d'acqua
Jardiniera con desagüe de agua
Jardinière avec évacuation de l'eau



JONATHAN

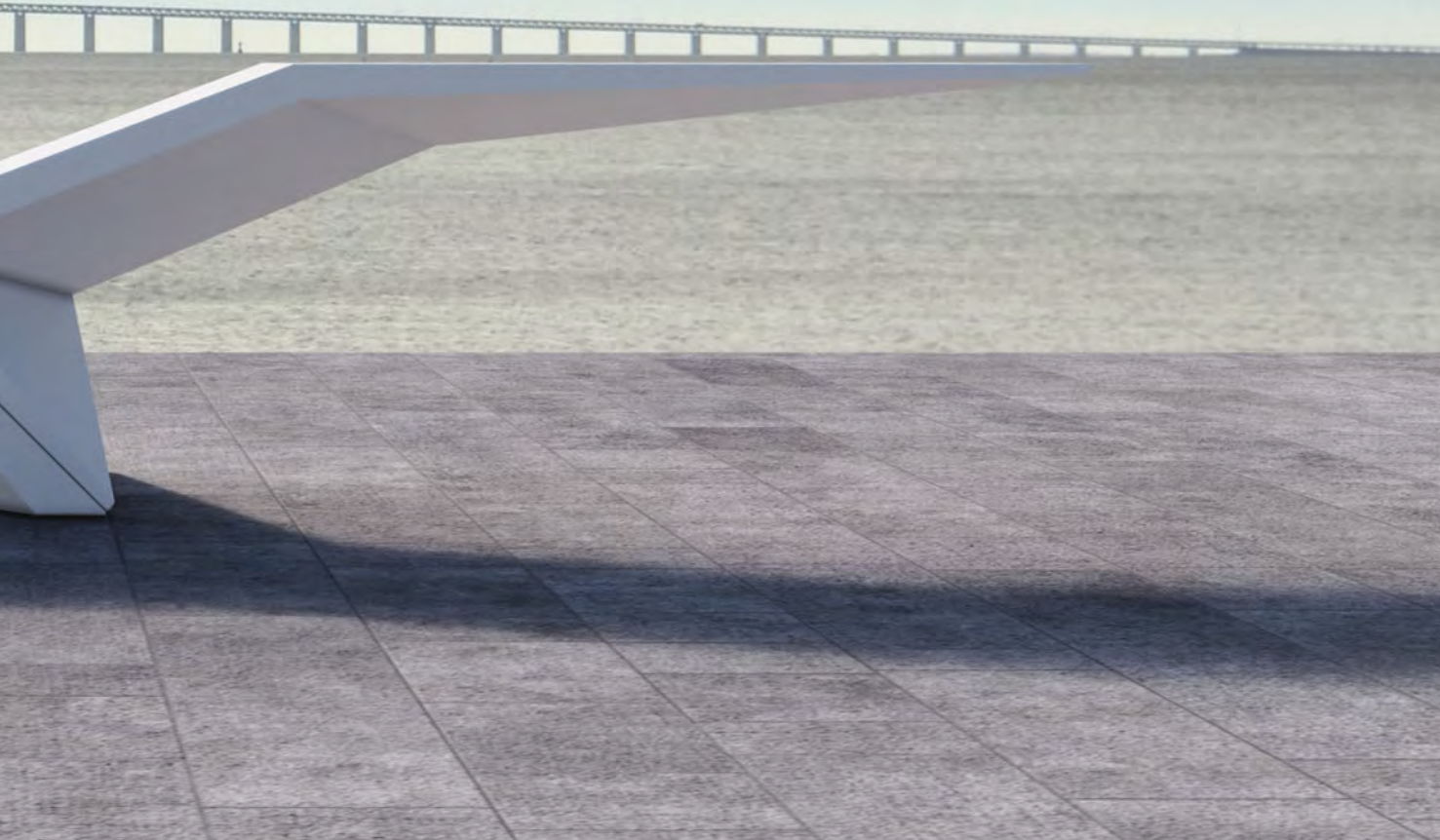



JONATHAN

DEL PONTE, ZAMBELLI

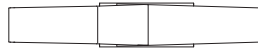
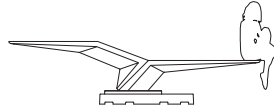

L 3751 mm
W 634 mm
H 738 mm
1110 kg

MATERIALS / MATERIALI / MATERIALES / MATÉRIAUX:

ULTRATENSE CONCRETE®



FINISHING / FINITURE / ACABADOS / FINITIONS:



ACCESSORIES / ACCESSORI / ACCESORIOS / ACCESSOIRES:













ARROW

C + S ARCHITECTS

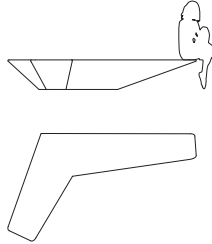

L 2550 mm
W 1456 mm
H 400 mm
819 kg

MATERIALS / MATERIALI / MATERIALES / MATÉRIAUX:
PIETRE PREZIOSE GRANITO



FINISHING / FINITURE / ACABADOS / FINITIONS:



ACCESSORIES / ACCESSORI / ACCESORIOS / ACCESSOIRES:

















A curved concrete bench with a wooden slat top, part of the Demetra Collection. The bench is made of light grey concrete blocks and is topped with light-colored wooden slats. The slats are arranged in a curved pattern, following the shape of the bench. The bench is set against a plain white background.

DEMETRA COLLECTION

WITHOUT LEVELING SYSTEM WITHOUT LED LIGHT



The DEMETRA collection can be offered without the levelling system for all those situations where the ground is flat.

La collezione DEMETRA può essere offerta senza il sistema di livellamento per tutte quelle situazioni in cui il terreno è pianeggiante.

La colección DEMETRA se puede ofrecer sin el sistema de nivelación para todas aquellas situaciones en las que el terreno sea llano.

La collection DEMETRA peut être proposée sans système de nivellement pour toutes les situations où le terrain est plat.

DEMETRA COLLECTION

WITH LEVELING SYSTEM
WITH LED LIGHT

UNTIL **6%**

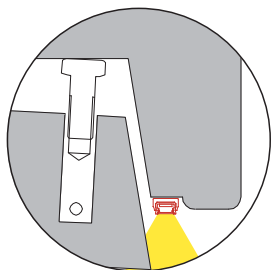
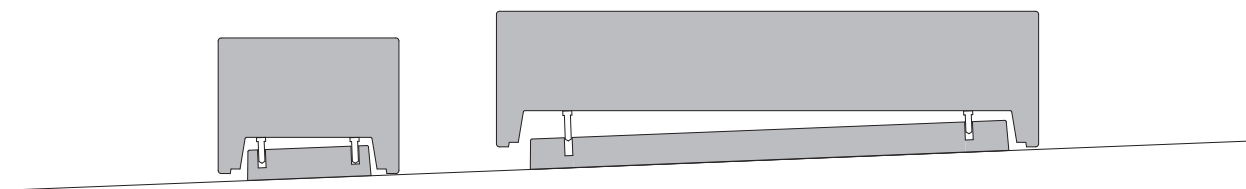

The leveling system is one of the main patented features that has made Bellitalia® products famous. This feature compensates for sloping ground that has a gradient of up to 6%, achieving a levelled effect from a visual point of view.

Uno dei principali sistemi funzionali brevettati che hanno reso famosi i prodotti di Bellitalia®, è sicuramente il sistema di livellamento. Esso permette di compensare la pendenza del terreno fino ad un massimo del 6% ottenendo un effetto piano da un punto di vista visivo.

Uno de los principales sistemas funcionales patentados que han hecho famosos a los productos es, sin duda, el sistema de nivelación. Permite compensar la pendiente del suelo hasta un máximo del 6% obteniendo un efecto plano desde un punto de vista del conjunto.

Bellitalia® doit son succès aussi à un système breveté pour niveler le produit au sol : la pente du terrain jusqu'à 6% ainsi compensée horizontalement donne l'effet d'un élément posé droit.



DEMETRA BENCHES

BELLITALIA DESIGN

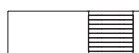
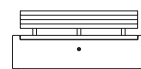
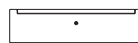
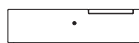
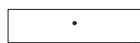

DEMETRA D

L 1800 mm
W 600 mm
H 480 mm
1170 kg

DEMETRA DW

L 1800 mm
W 600 mm
H 480 mm
1155 kg

DEMETRA 2DW

L 1800 mm
W 600 mm
H 480 mm
1099 kg

DEMETRA 2DWS

L 1800 mm
W 600 mm
H 812 mm
1132 kg

MATERIALS / MATERIALI / MATERIALES / MATÉRIAUX:

PIETRE PREZIOSE



GRANITO



WOOD
LEGNO
MADERA
BOIS



FINISHING / FINITURE / ACABADOS / FINITIONS:



ACCESSORIES / ACCESSORI / ACCESORIOS / ACCESSOIRES:





DEMETRA BENCHES

BELLITALIA DESIGN

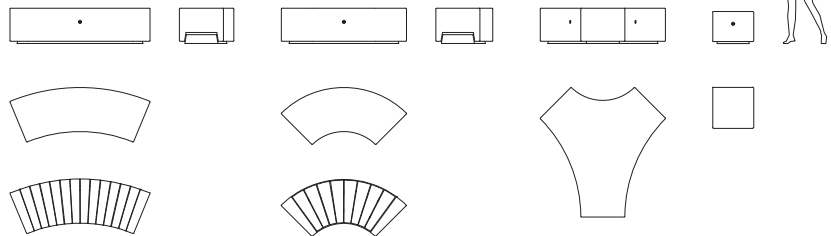

DEMETRA CA/CAW

L 1907 mm
W 742 mm
H 480 mm
1139 kg

DEMETRA CC/CCW

L 1705 mm
W 600 mm
H 480 mm
944 kg

DEMETRA Y

L 1705 mm
W 1764 mm
H 480 mm
1881 kg

DEMETRA M

L 600 mm
W 600 mm
H 450 mm
380 kg

MATERIALS / MATERIALI / MATERIALES / MATÉRIAUX:

PIETRE PREZIOSE



GRANITO



WOOD
LEGNO
MADERA
BOIS



FINISHING / FINITURE / ACABADOS / FINITIONS:



ACCESSORIES / ACCESSORI / ACCESORIOS / ACCESSOIRES:









DEMETRA PLANTERS

BELLITALIA DESIGN

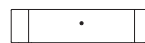

DEMETRA F

L 600 mm
W 600 mm
H 480 mm
270 kg
42 lt

DEMETRA FD

L 1800 mm
W 600 mm
H 480 mm
740 kg
330 lt

DEMETRA FC

L 1907 mm
W 742 mm
H 480 mm
737 kg
300 lt

MATERIALS / MATERIALI / MATERIALES / MATÉRIAUX:

PIETRE PREZIOSE

GRANITO



FINISHING / FINITURE / ACABADOS / FINITIONS:



ACCESSORIES / ACCESSORI / ACCESORIOS / ACCESSOIRES:





*THE TABLE IS NOT PART OF THE COLLECTION









DEMETRA COLLECTION

BELLITALIA DESIGN



*THE TABLE IS NOT PART OF THE COLLECTION







A nighttime photograph of an outdoor plaza. In the foreground, several large, circular, light-colored concrete tables are arranged on a paved surface. The tables have a slightly raised, tiered design. In the background, several bare trees are scattered across the plaza. Tall, slender light poles with multiple lamps are visible, casting a soft glow. The overall atmosphere is quiet and modern.

LIDÒ COLLECTION







LIDÒ

C + S ARCHITECTS

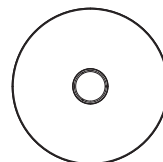
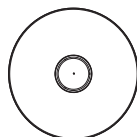
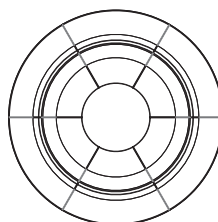
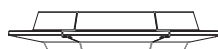
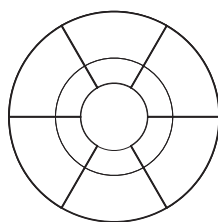

LIDÒ 2000
 Ø 2000 mm
 Ø 472 mm
 H 412 mm
 1415 kg

LIDÒ 2500
 Ø 2500 mm
 Ø 472 mm
 H 412 mm
 2360 kg

LIDÒ 4500
 Ø 4500 mm
 Ø 1440 mm
 H 412 mm
 8700 kg

LIDÒ 4500 S
 Ø 4500 mm
 Ø 1420 mm
 H 800 mm
 10030 kg



LIDÒ

C + S ARCHITECTS

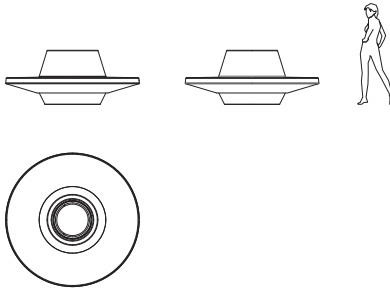

LIDÒ 2000 S

Ø 2000 mm

Ø 744 mm

H 812 mm

1735 kg



MATERIALS / MATERIALI / MATERIALES / MATÉRIAUX:

PIETRE PREZIOSE

GRANITO



FINISHING / FINITURE / ACABADOS / FINITIONS:



ACCESSORIES / ACCESSORI / ACCESORIOS / ACCESSOIRES:











SHAOLIN COLLECTION



SHAOLIN

MASSIMO TASCA



SHAOLIN S

L 1000 mm
W 530 mm
H 450 mm
217 kg

SHAOLIN L

L 2000 mm
W 530 mm
H 450 mm
435 kg

MATERIALS / MATERIALI / MATERIALES / MATÉRIAUX:
PIETRE PREZIOSE GRANITO



FINISHING / FINITURE / ACABADOS / FINITIONS:



ACCESSORIES / ACCESSORI / ACCESORIOS / ACCESSOIRES:





SHAOLIN T



SHAOLIN CA



SHAOLIN CC



SHAOLIN S



SHAOLIN L

SHAOLIN

MASSIMO TASCA



SHAOLIN T

L 530 mm
W 80 mm
H 450 mm
34 kg

SHAOLIN CC

L 520 mm
W 530 mm
H 450 mm
80 kg

SHAOLIN CA

L 1045 mm
W 530 mm
H 450 mm
163 kg

MATERIALS / MATERIALI / MATERIALES / MATÉRIAUX:
PIETRE PREZIOSE GRANITO



FINISHING / FINITURE / ACABADOS / FINITIONS:



ACCESSORIES / ACCESSORI / ACCESORIOS / ACCESSOIRES:





SHAOLIN

MASSIMO TASCA





LOUNGE COLLECTION

BELLITALIA DESIGN

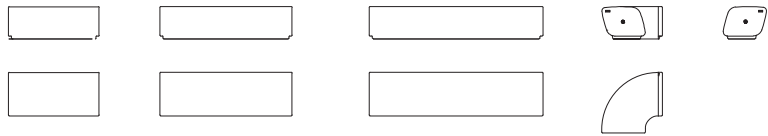

L 1220

L 1220 mm
W 585 mm
H 435 mm
470 kg

L 1780

L 1780 mm
W 585 mm
H 435 mm
650 kg

L 2340

L 2340 mm
W 585 mm
H 435 mm
870 kg

L 90

L 815 mm
W 815 mm
H 435 mm
433 kg

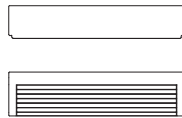

LW 2340

L 2340 mm
W 585 mm
H 718 mm
1130 kg



LOUNGE COLLECTION

BELLITALIA DESIGN



MATERIALS / MATERIALI / MATERIALES / MATÉRIAUX:

PIETRE PREZIOSE



GRANITO



WOOD
LEGNO
MADERA
BOIS



FINISHING / FINITURE / ACABADOS / FINITIONS:



ACCESSORIES / ACCESSORI / ACCESORIOS / ACCESSOIRES:











WING COLLECTION



WING UTC®

DEL PONTE, ZAMBELLI

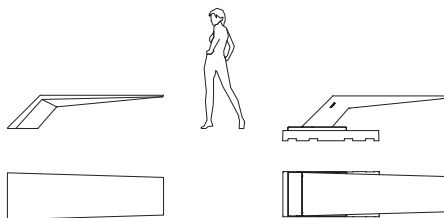
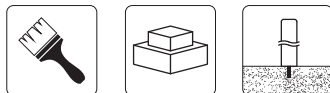

L 2114 mm
W 634 mm
H 450 mm
360 kg

L 2114 mm
W 634 mm
H 450 mm
710 kg

MATERIALS / MATERIALI / MATERIALES / MATÉRIAUX: ULTRATENSE CONCRETE®



FINISHING / FINITURE / ACABADOS / FINITIONS:



ACCESSORIES / ACCESSORI / ACCESORIOS / ACCESSOIRES:







⊙ ⊙ SZÉKTOR BEJÁRAT
ENTRANCE SECTORS

MEDIA

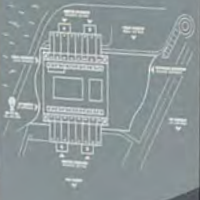



EAT.mei
Cucinare pace di qualità
EAT.mei
CORNICIONE RIFORMATA PAVESIA

RETE







Ostado

ALMAGRA QUART





WING WOOD

DEL PONTE, ZAMBELLI

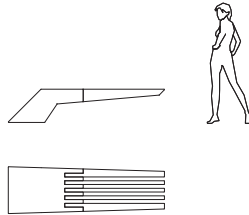

L 2114 mm
W 634 mm
H 450 mm
382 kg

MATERIALS / MATERIALI / MATERIALES / MATÉRIAUX:

PIETRE PREZIOSE



GRANITO



WOOD
LEGNO
MADERA
BOIS



FINISHING / FINITURE / ACABADOS / FINITIONS:



ACCESSORIES / ACCESSORI / ACCESORIOS / ACCESSOIRES:















BRAIES COLLECTION







BRAIES COLLECTION

BELLITALIA DESIGN

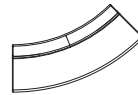
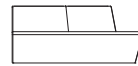

BRAIES D

L 2600 mm
W 650 mm
H 780 mm
h 430 mm
1124 kg

BRAIES CC

L 1944 mm
W 650 mm
H 780 mm
h 430 mm
773 kg



MATERIALS / MATERIALI / MATERIALES / MATÉRIAUX:
HIGHTENSE CONCRETE



FINISHING / FINITURE / ACABADOS / FINITIONS:



ACCESSORIES / ACCESSORI / ACCESORIOS / ACCESSOIRES:





BRAIES COLLECTION

BELLITALIA DESIGN





BRAIES COLLECTION

BELLITALIA DESIGN





DOLOMITI

MASSIMO TASCA

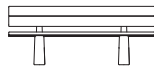

L 2000 mm
W 770 mm
H 800 mm
h 450 mm
197 kg

MATERIALS / MATERIALI / MATERIALES / MATÉRIAUX:

HIGHTENSE CONCRETE

WOOD
LEGNO
MADERA
BOIS



FINISHING / FINITURE / ACABADOS / FINITIONS:



ACCESSORIES / ACCESSORI / ACCESORIOS / ACCESSOIRES:





DOLOMITI

MASSIMO TASCA









VERKE
TH



ONDA COLLECTION

WITHOUT LEVELING SYSTEM WITH LED LIGHT

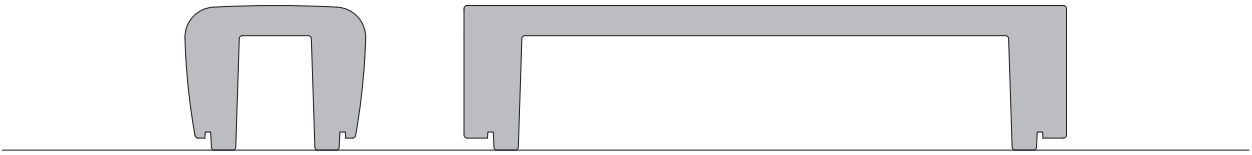

The ONDA collection can be offered without the levelling system for all those situations where the ground is flat.

La collezione ONDA può essere offerta senza il sistema di livellamento per tutte quelle situazioni in cui il terreno è pianeggiante.

La colección ONDA se puede ofrecer sin el sistema de nivelación para todas aquellas situaciones en las que el suelo sea llano.

La collection ONDA peut être proposée sans système de nivellement pour toutes les situations où le terrain est plat.

ONDA COLLECTION

LORENZO TOSOLINI

WITH LEVELING SYSTEM
WITH LED LIGHT

UNTIL **6%**

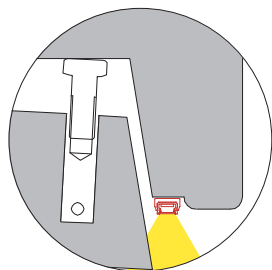
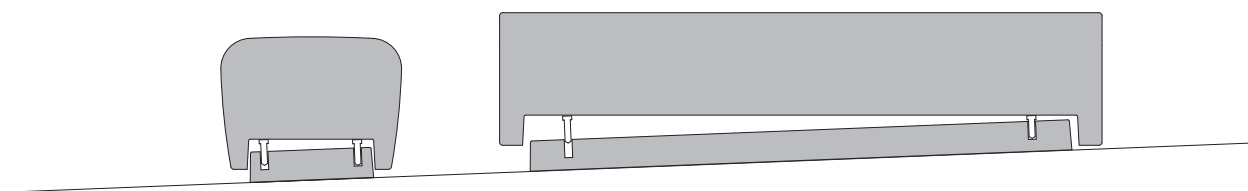

The leveling system is one of the main patented features that has made Bellitalia® products famous. This feature compensates for sloping ground that has a gradient of up to 6%, achieving a levelled effect from a visual point of view.

Uno dei principali sistemi funzionali brevettati che hanno reso famosi i prodotti di Bellitalia®, è sicuramente il sistema di livellamento. Esso permette di compensare la pendenza del terreno fino ad un massimo del 6% ottenendo un effetto piano da un punto di vista visivo.

Uno de los principales sistemas funcionales patentados que han hecho famosos a los productos es, sin duda, el sistema de nivelación. Permite compensar la pendiente del suelo hasta un máximo del 6% obteniendo un efecto plano desde un punto de vista del conjunto.

Bellitalia® doit son succès aussi à un système breveté pour niveler le produit au sol : la pente du terrain jusqu'à 6% ainsi compensée horizontalement donne l'effet d'un élément posé droit.



ONDA BENCHES

LORENZO TOSOLINI

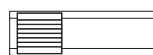
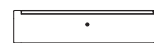
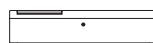
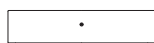

ONDA D

L 2000 mm
W 600 mm
H 470 mm
1209 kg

ONDA DW

L 2000 mm
W 600 mm
H 470 mm
1185 kg

ONDA 2DW

L 2000 mm
W 600 mm
H 470 mm
1133 kg

MATERIALS / MATERIALI / MATERIALES / MATÉRIAUX:

PIETRE PREZIOSE



GRANITO



WOOD LEGNO MADERA BOIS



FINISHING / FINITURE / ACABADOS / FINITIONS:



ACCESSORIES / ACCESSORI / ACCESORIOS / ACCESSOIRES:





ONDA BENCHES

LORENZO TOSOLINI



ONDA C

L 1990 mm
W 750 mm
H 470 mm
1060 kg



ONDA CW

L 1982 mm
W 750 mm
H 470 mm
1015 kg

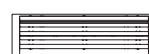

ONDA 2DWS

L 2000 mm
W 600 mm
H 804 mm
1178 kg



MATERIALS / MATERIALI / MATERIALES / MATÉRIAUX:

PIETRE PREZIOSE



GRANITO



WOOD
LEGNO
MADERA
BOIS



FINISHING / FINITURE / ACABADOS / FINITIONS:



ACCESSORIES / ACCESSORI / ACCESORIOS / ACCESSOIRES:





BAHNHOF POTSDAMER PLATZ

LED LIGHT IS NOT STANDARD CONFIGURATION

ONDA PLANTERS

LORENZO TOSOLINI

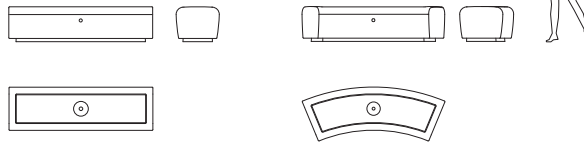

ONDA F

L 2000 mm
W 600 mm
H 470 mm
790 kg
151 lt

ONDA FC

L 1990 mm
W 752 mm
H 470 mm
730 kg
133 lt

MATERIALS / MATERIALI / MATERIALES / MATÉRIAUX:

PIETRE PREZIOSE

GRANITO



FINISHING / FINITURE / ACABADOS / FINITIONS:



ACCESSORIES / ACCESSORI / ACCESORIOS / ACCESSOIRES:















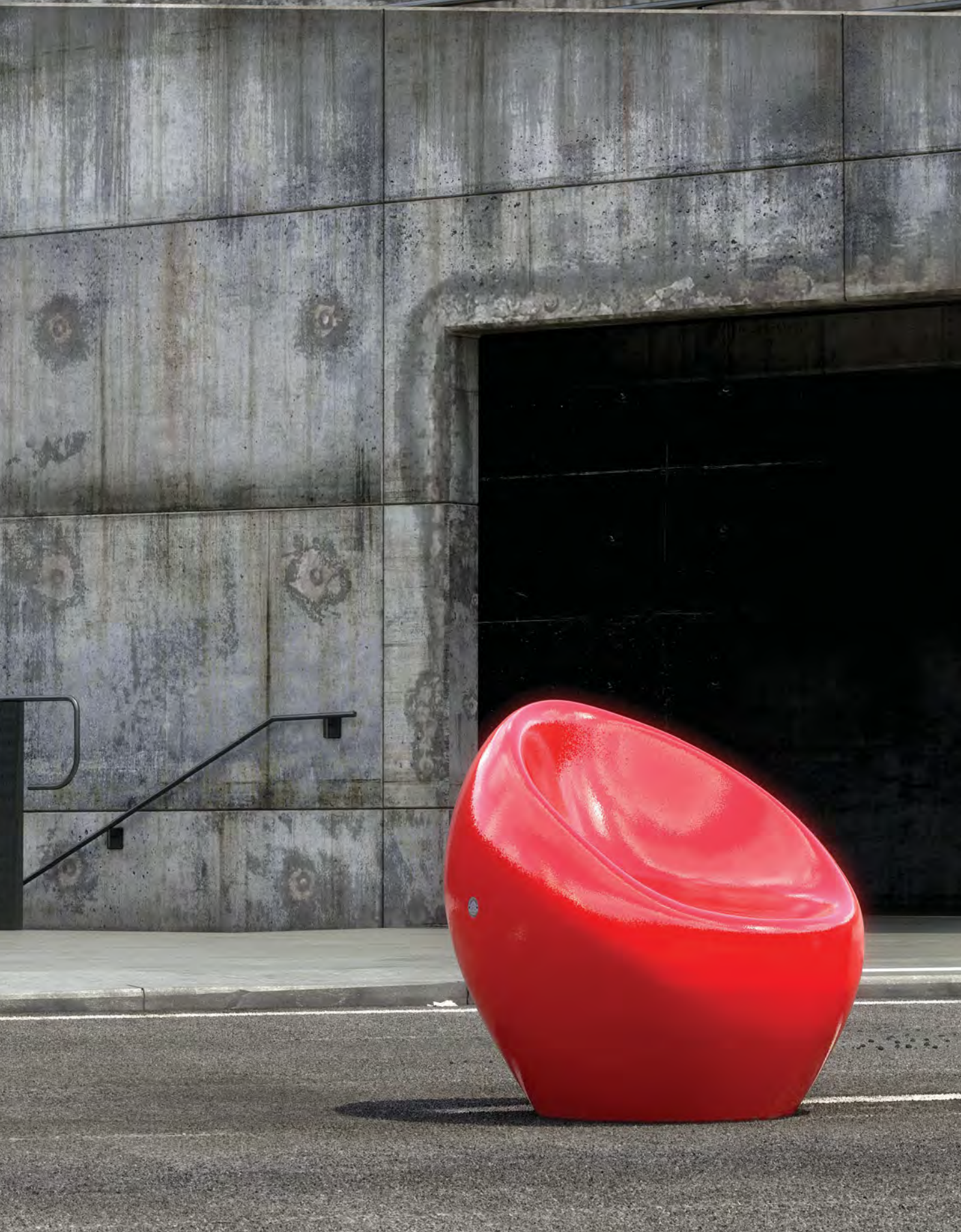

A vibrant red, organic-shaped chair is positioned in the foreground on a dark asphalt surface. The chair has a smooth, glossy finish and a rounded, bowl-like form. In the background, a large, weathered concrete wall with visible texture and some discoloration serves as the backdrop. Above the wall, a concrete structure with a black metal railing and a yellow and black striped warning sign is visible. The overall scene is an industrial or urban environment.

ORGANIC COLLECTION



CUDDLY

MATOUŠ HOLÝ



L 828 mm
W 845 mm
H 830 mm
660 kg

MATERIALS / MATERIALI / MATERIALES / MATÉRIAUX:

WHITE GRANITO
GRANITO BIANCO
GRANITO BLANCO
GRANIT BLANC



FINISHING / FINITURE / ACABADOS / FINITIONS:



ACCESSORIES / ACCESSORI / ACCESORIOS / ACCESSOIRES:





HAPPY

MATOUŠ HOLÝ

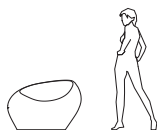

L 960 mm
W 655 mm
H 662 mm
505 kg

MATERIALS / MATERIALI / MATERIALES / MATÉRIAUX:

WHITE GRANITO
GRANITO BIANCO
GRANITO BLANCO
GRANIT BLANC



FINISHING / FINITURE / ACABADOS / FINITIONS:



ACCESSORIES / ACCESSORI / ACCESORIOS / ACCESSOIRES:



CE

WAREH



FUNNY

BELLITALIA DESIGN



L 2013 mm
W 1017 mm
H 580 mm
1880 kg

MATERIALS / MATERIALI / MATERIALES / MATÉRIAUX:

WHITE GRANITO
GRANITO BIANCO
GRANITO BLANCO
GRANIT BLANC



FINISHING / FINITURE / ACABADOS / FINITIONS:



ACCESSORIES / ACCESSORI / ACCESORIOS / ACCESSOIRES:





FAMILY

MATOUŠ HOLÝ

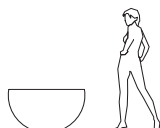

Ø 960 mm
H 520 mm
695 kg

MATERIALS / MATERIALI / MATERIALES / MATÉRIAUX:

WHITE GRANITO
GRANITO BIANCO
GRANITO BLANCO
GRANIT BLANC



FINISHING / FINITURE / ACABADOS / FINITIONS:



ACCESSORIES / ACCESSORI / ACCESORIOS / ACCESSOIRES:





HARMONY

MATOUŠ HOLÝ

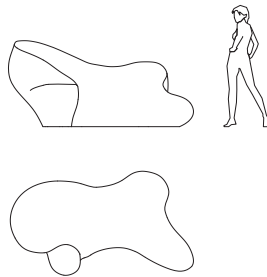

L 2390 mm
W 1400 mm
H 1080 mm
2525 kg

MATERIALS / MATERIALI / MATERIALES / MATÉRIAUX:

WHITE GRANITO
GRANITO BIANCO
GRANITO BLANCO
GRANIT BLANC



FINISHING / FINITURE / ACABADOS / FINITIONS:



ACCESSORIES / ACCESSORI / ACCESORIOS / ACCESSOIRES:















LABYRINTH COLLECTION



LABYRINTH

BELLITALIA DESIGN

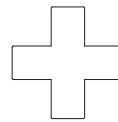
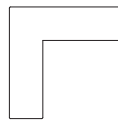
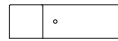

ATE

L 1500 mm
W 450 mm
H 450 mm
760 kg

IRIS

L 1500 mm
W 1500 mm
H 450 mm
1264 kg

EOS

L 1500 mm
W 1500 mm
H 450 mm
1264 kg

MATERIALS / MATERIALI / MATERIALES / MATÉRIAUX:

PIETRE PREZIOSE

GRANITO



FINISHING / FINITURE / ACABADOS / FINITIONS:



ACCESSORIES / ACCESSORI / ACCESORIOS / ACCESSOIRES:





LABYRINTH

BELLITALIA DESIGN

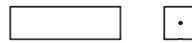

IDRA

L 450 mm
W 450 mm
H 450 mm
223 kg

ATE F*

L 1500 mm
W 450 mm
H 450 mm
310 kg

REA

L 713 mm
W 713 mm
H 750 mm
180 kg



MATERIALS / MATERIALI / MATERIALES / MATÉRIAUX:

PIETRE PREZIOSE

GRANITO

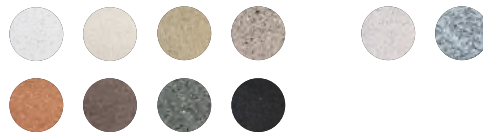

FINISHING / FINITURE / ACABADOS / FINITIONS:



ACCESSORIES / ACCESSORI / ACCESORIOS / ACCESSOIRES:







بيت الأطباق اللبنانية
SAJ EXPRESS
RESTAURANT

بيت الأطباق اللبنانية
Authentic
Lebanese Cuisine

20

الس
شباب

2 IRIS



2 IRIS + 2 ATE



4 IDRA



1 EOS

2 IRIS + 2 IDRA



3 ATE F



2 IRIS + REA

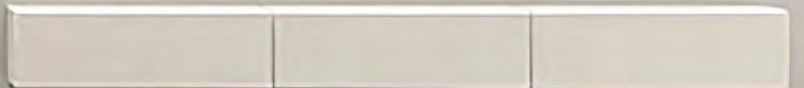

3 ATE



CLIP

ALFREDO TASCA

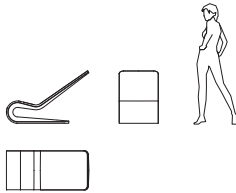

L 1187 mm
H 839 mm
W 600 mm
170 kg

MATERIALS / MATERIALI / MATERIALES / MATÉRIAUX:
ULTRATENSE CONCRETE®



FINISHING / FINITURE / ACABADOS / FINITIONS:



ACCESSORIES / ACCESSORI / ACCESORIOS / ACCESSOIRES:





CLIP

ALFREDO TASCA





CLIP

ALFREDO TASCA



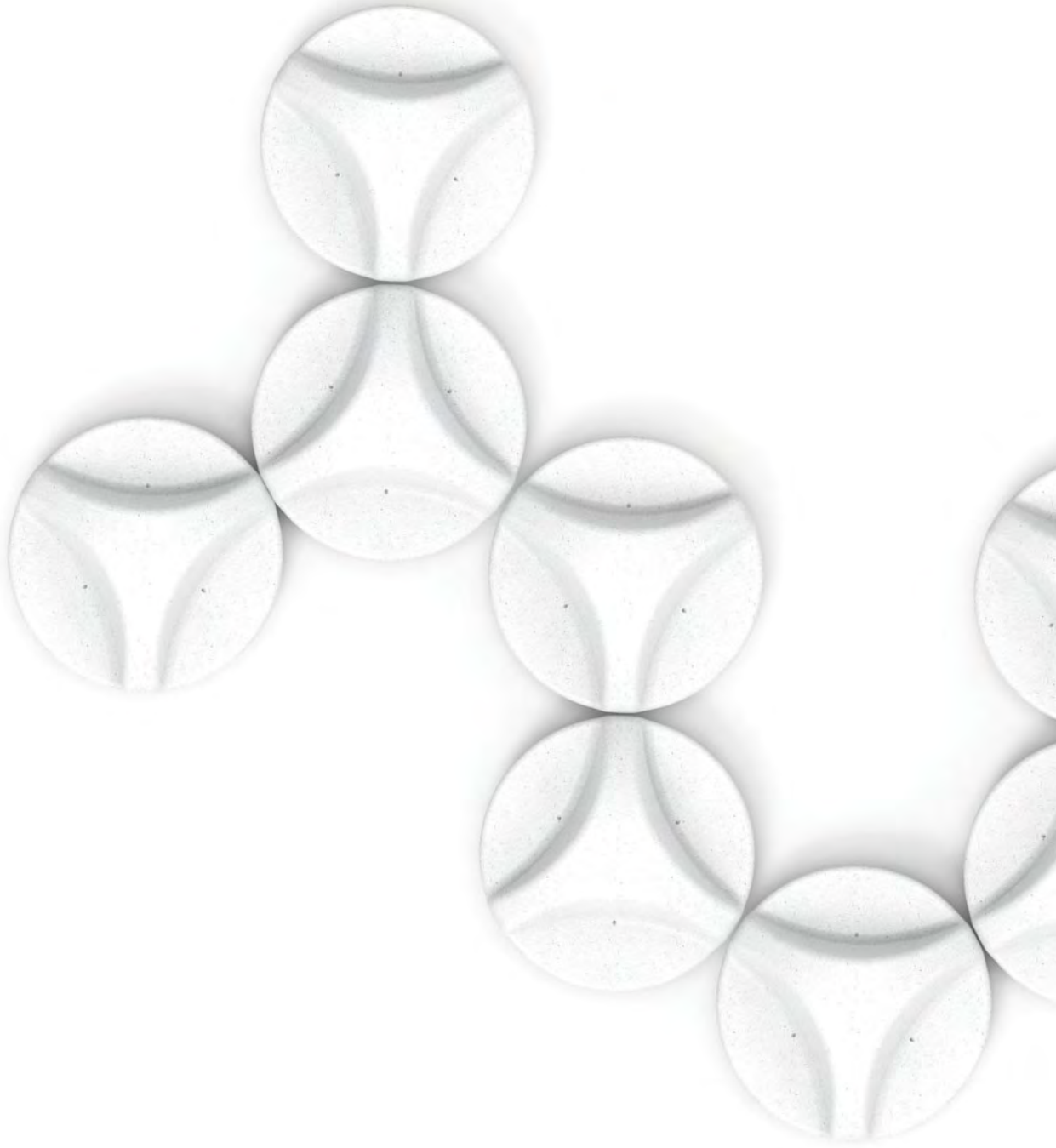

DNA

ALESSANDRO LENARDA

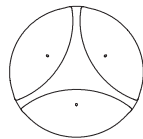

Ø 1900 mm
H 850 mm
2360 kg



MATERIALS / MATERIALI / MATERIALES / MATÉRIAUX:
PIETRE PREZIOSE GRANITO

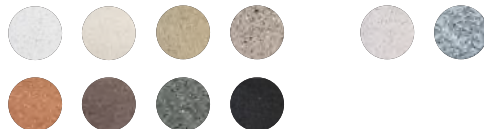

FINISHING / FINITURE / ACABADOS / FINITIONS:



ACCESSORIES / ACCESSORI / ACCESORIOS / ACCESSOIRES:





when the city becomes a living room
quando la città prende la forma di un salotto
cuando la ciudad se transforma en una sala de estar
quand la ville devient un salon





DNA

ALESSANDRO LENARDA







KUBB COLLECTION



KUBB BENCHES

BELLITALIA DESIGN

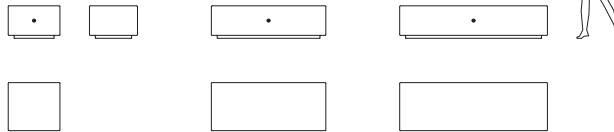

KUBB M

L 700 mm
W 650 mm
H 440 mm
472 kg

KUBB D

L 1550 mm
W 650 mm
H 440 mm
1054 kg

KUBB 2D

L 2000 mm
W 650 mm
H 440 mm
1362 kg



MATERIALS / MATERIALI / MATERIALES / MATÉRIAUX:
PIETRE PREZIOSE GRANITO

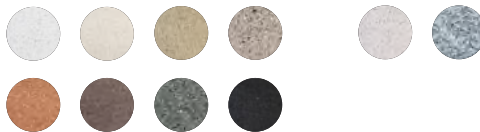

FINISHING / FINITURE / ACABADOS / FINITIONS:



ACCESSORIES / ACCESSORI / ACCESORIOS / ACCESSOIRES:





KUBB BENCHES

BELLITALIA DESIGN

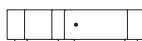
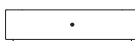

KUBB CC

L 1807 mm
W 768 mm
H 440 mm

1104 kg

KUBB Y

L 1864 mm
W 1438 mm
H 440 mm

1643 kg

MATERIALS / MATERIALI / MATERIALES / MATÉRIAUX:

PIETRE PREZIOSE

GRANITO



FINISHING / FINITURE / ACABADOS / FINITIONS:



ACCESSORIES / ACCESSORI / ACCESORIOS / ACCESSOIRES:





KUBB PLANTERS

BELLITALIA DESIGN

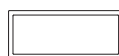
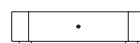

KUBB F

L 700 mm
W 650 mm
H 440 mm
200 kg
104 lt

KUBB 2F

L 2000 mm
W 650 mm
H 440 mm
386 kg
251 lt

KUBB FC

L 1806 mm
W 768 mm
H 440 mm
401 kg
167 lt

MATERIALS / MATERIALI / MATERIALES / MATÉRIAUX:

PIETRE PREZIOSE

GRANITO



FINISHING / FINITURE / ACABADOS / FINITIONS:



ACCESSORIES / ACCESSORI / ACCESORIOS / ACCESSOIRES:





NOT STANDARD CONFIGURATION

KUBB COLLECTION

BELLITALIA DESIGN

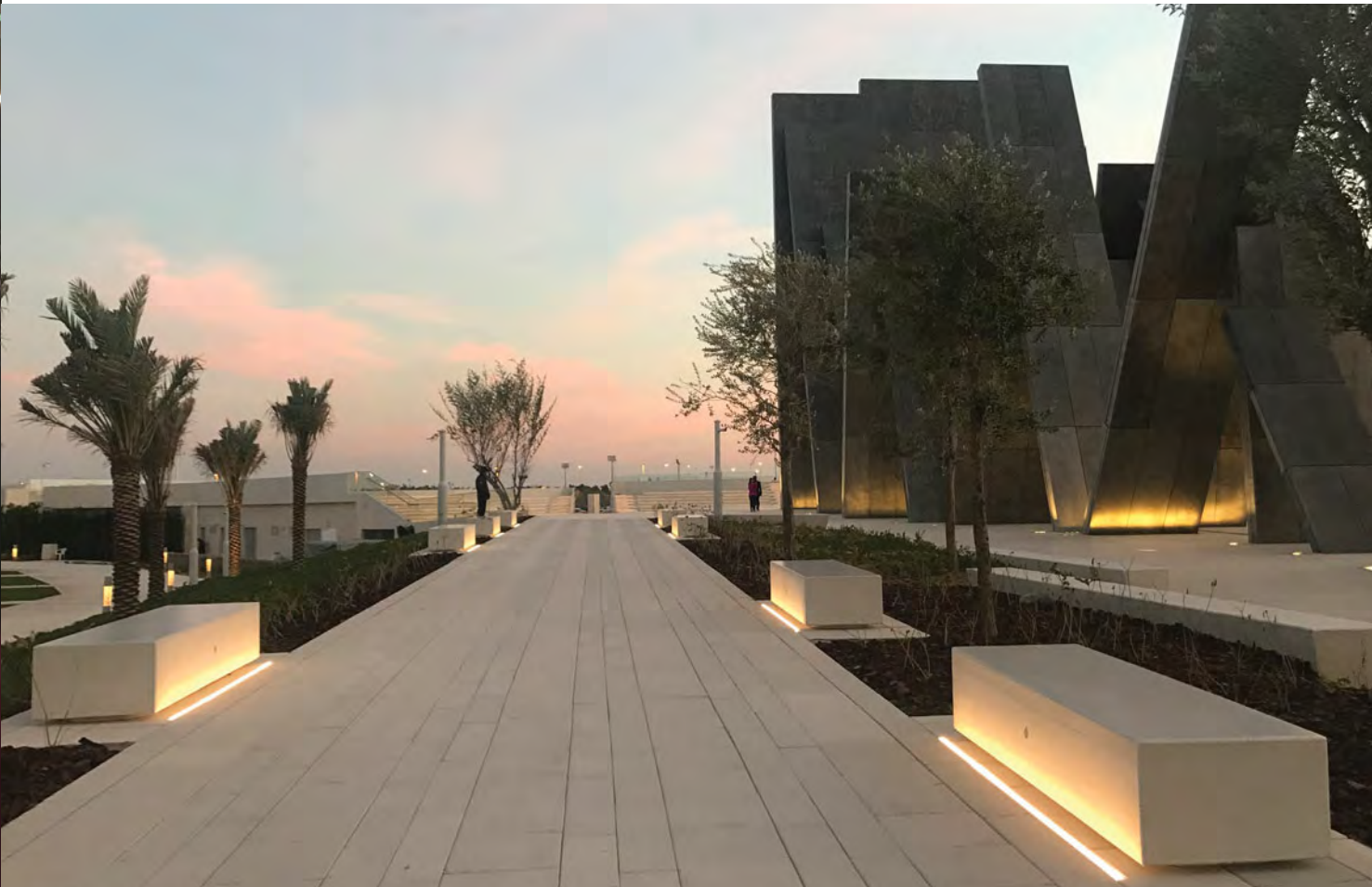







OPRUIMING

BAJAS
OPRUIMING
ALDES
ALDOS
BAJAS

9

OPRUIMING
-50%

20

30

50

-20%

Solden

01/07





RETTA

MASSIMO TASCA

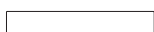
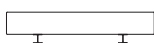

L 2000 mm
W 300 mm
H 420 mm
441 kg

MATERIALS / MATERIALI / MATERIALES / MATÉRIAUX:

POWDER COATED STEEL
ACCIAIO VERNICIATO
ACERO PINTADO
ACIER THERMOLAQUÉ

HIGHTENSE CONCRETE



FINISHING / FINITURE / ACABADOS / FINITIONS:



ACCESSORIES / ACCESSORI / ACCESORIOS / ACCESSOIRES:





RETTA

MASSIMO TASCA







OLIMPO COLLECTION



OLIMPO

BELLITALIA DESIGN

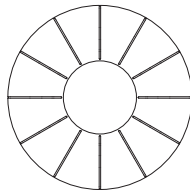
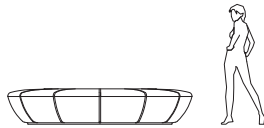

Ø 2500 mm
 Ø 1260 mm
 H 480 mm
 3550 kg
 585 lt

MATERIALS / MATERIALI / MATERIALES / MATÉRIAUX:

PIETRE PREZIOSE

GRANITO



FINISHING / FINITURE / ACABADOS / FINITIONS:



ACCESSORIES / ACCESSORI / ACCESORIOS / ACCESSOIRES:









OLIMPO S

BELLITALIA DESIGN

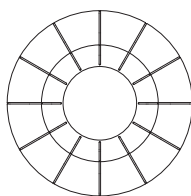
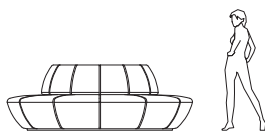

Ø 1040 mm
 Ø 2500 mm
 H 880 mm
 4500 kg
 733 lt

MATERIALS / MATERIALI / MATERIALES / MATÉRIAUX:

PIETRE PREZIOSE

GRANITO

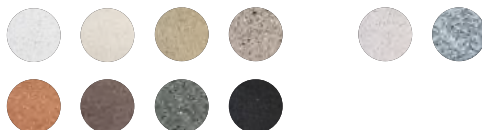

FINISHING / FINITURE / ACABADOS / FINITIONS:



ACCESSORIES / ACCESSORI / ACCESORIOS / ACCESSOIRES:







**RING - RING REVERSE
COLLECTION**



RING - RING REVERSE

BELLITALIA COLLECTION

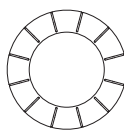

RING REVERSE

Ø 1576 mm
Ø 992 mm
H 480 mm
963 kg
400 lt

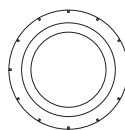

RING

Ø 1576 mm
Ø 992 mm
H 480 mm
963 kg
400 lt

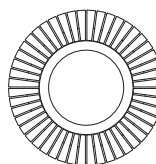

RING W

Ø 2052 mm
Ø 992 mm
H 480 mm
1039 kg
400 lt

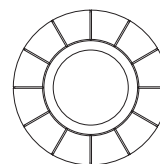
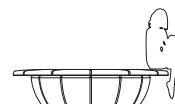

RING C

Ø 2052 mm
Ø 992 mm
H 480 mm
1320 kg
400 lt

MATERIALS / MATERIALI / MATERIALES / MATÉRIAUX:

PIETRE PREZIOSE



GRANITO



WOOD
LEGNO
MADERA
BOIS



FINISHING / FINITURE / ACABADOS / FINITIONS:



ACCESSORIES / ACCESSORI / ACCESORIOS / ACCESSOIRES:









RING - RING REVERSE

BELLITALIA COLLECTION







**VENEZIA - ERACLEA
COLLECTION**



ERACLEA TABLE

BELLITALIA DESIGN

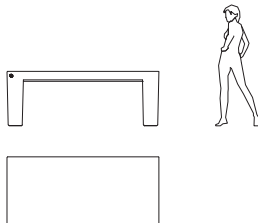

L 2200 mm
W 976 mm
H 780 mm
1485 kg

MATERIALS / MATERIALI / MATERIALES / MATÉRIAUX:

PIETRE PREZIOSE

GRANITO



FINISHING / FINITURE / ACABADOS / FINITIONS:



ACCESSORIES / ACCESSORI / ACCESORIOS / ACCESSOIRES:













ERACLEA

BELLITALIA DESIGN

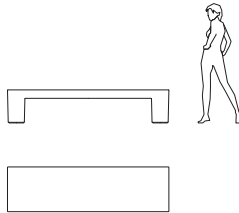

L 2200 mm
W 610 mm
H 450 mm
595 kg

MATERIALS / MATERIALI / MATERIALES / MATÉRIAUX:
PIETRE PREZIOSE GRANITO

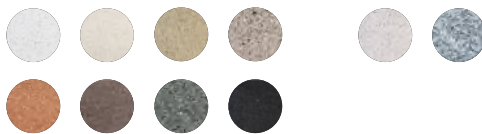

FINISHING / FINITURE / ACABADOS / FINITIONS:



ACCESSORIES / ACCESSORI / ACCESORIOS / ACCESSOIRES:





ERACLEA

BELLITALIA DESIGN





ERACLEA BACK

BELLITALIA DESIGN

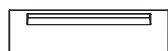
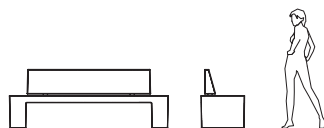

L 2200 mm
I 1709 mm
W 605 mm
H 812 mm
h 450 mm
733 kg

MATERIALS / MATERIALI / MATERIALES / MATÉRIAUX:

PIETRE PREZIOSE

GRANITO



FINISHING / FINITURE / ACABADOS / FINITIONS:



ACCESSORIES / ACCESSORI / ACCESORIOS / ACCESSOIRES:





ERACLEA BACK

BELLITALIA DESIGN





ERACLEA WOOD

MATTEO CESCHINI

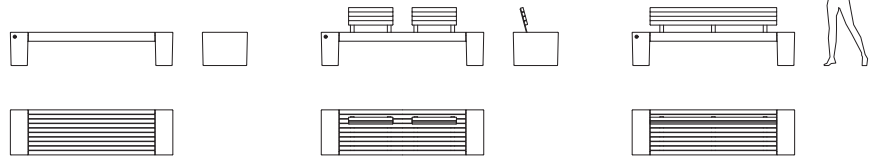

ERACLEA W

L 2200 mm
W 610 mm
H 450 mm
500 kg

ERACLEA WSD

L 2200 mm
W 610 mm
H 784 mm
514 kg

ERACLEA WS

L 2200 mm
W 610 mm
H 784 mm
517 kg

MATERIALS / MATERIALI / MATERIALES / MATÉRIAUX:

PIETRE PREZIOSE



GRANITO



WOOD
LEGNO
MADERA
BOIS



FINISHING / FINITURE / ACABADOS / FINITIONS:



ACCESSORIES / ACCESSORI / ACCESORIOS / ACCESSOIRES:





NOT STANDARD CONFIGURATION

ERACLEA WOOD

MATTEO CESCHINI



NOT STANDARD CONFIGURATION



ERACLEA WOOD

MATTEO CESCHINI

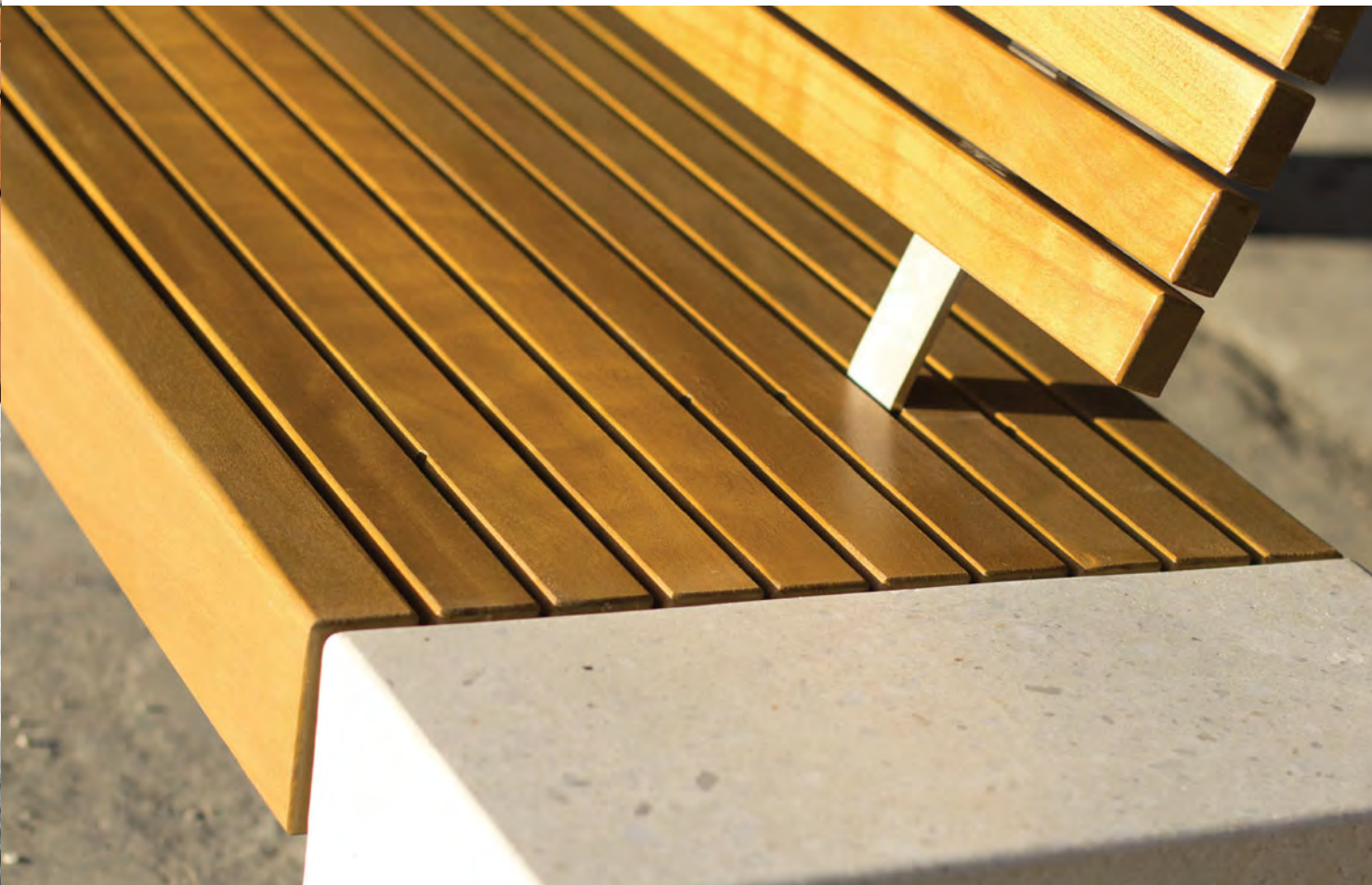



ERACLEA GRES

MATTEO CESCHINI

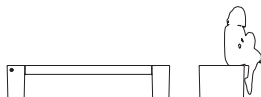

L 2200 mm
W 610 mm
H 450 mm
505 kg

MATERIALS / MATERIALI / MATERIALES / MATÉRIAUX:

PIETRE PREZIOSE



GRANITO



PORCELAIN STONEWARE
GRES PORCELLANATO
GRES PORCELÁNICO
GRÈS PORCELAINÉ



FINISHING / FINITURE / ACABADOS / FINITIONS:



ACCESSORIES / ACCESSORI / ACCESORIOS / ACCESSOIRES:





VENEZIA - VENEZIA WOOD

BELLITALIA DESIGN

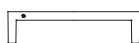

VENEZIA

L 1900 mm
W 450 mm
H 450 mm
340 kg

VENEZIA WOOD

L 1900 mm
W 450 mm
H 450 mm
266 kg

MATERIALS / MATERIALI / MATERIALES / MATÉRIAUX:

PIETRE PREZIOSE



GRANITO



WOOD
LEGNO
MADERA
BOIS



FINISHING / FINITURE / ACABADOS / FINITIONS:



ACCESSORIES / ACCESSORI / ACCESORIOS / ACCESSOIRES:





VENEZIA BABY&OLD

MASSIMO TASCA

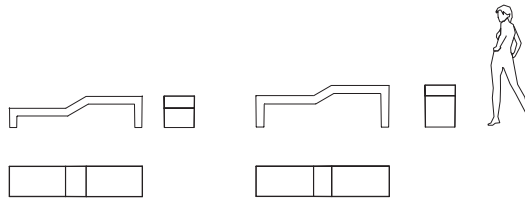

VENEZIA BABY

L 1910 mm
W 450 mm
H 450 mm
h 280 mm
303 kg

VENEZIA OLD

L 1910 mm
W 440 mm
H 600 mm
h 450 mm
342 kg



MATERIALS / MATERIALI / MATERIALES / MATÉRIAUX:

PIETRE PREZIOSE

GRANITO

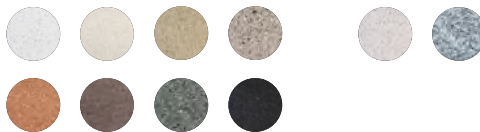

FINISHING / FINITURE / ACABADOS / FINITIONS:



ACCESSORIES / ACCESSORI / ACCESORIOS / ACCESSOIRES:









AURORA

BELLITALIA DESIGN



L 2250 mm
W 900 mm
H 750 mm
479 kg

MATERIALS / MATERIALI / MATERIALES / MATÉRIAUX:

ULTRATENSE CONCRETE®

**FINISHING / FINITURE / ACABADOS / FINITIONS:****ACCESSORIES / ACCESSORI / ACCESORIOS / ACCESSOIRES:**



AURORA

BELLITALIA DESIGN









ALBA

BELLITALIA DESIGN

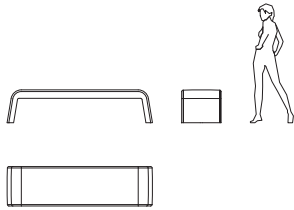

L 1990 mm
W 540 mm
H 450 mm
230 kg

MATERIALS / MATERIALI / MATERIALES / MATÉRIAUX:
ULTRATENSE CONCRETE®



FINISHING / FINITURE / ACABADOS / FINITIONS:



ACCESSORIES / ACCESSORI / ACCESORIOS / ACCESSOIRES:





EVERYTHING IS
A WORK
IN PROGRESS

TU
MAGNUS
SCIENCE

APOLLO

BELLITALIA DESIGN

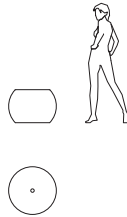

Ø 650 mm
H 450 mm
307 kg

MATERIALS / MATERIALI / MATERIALES / MATÉRIAUX:
PIETRE PREZIOSE GRANITO

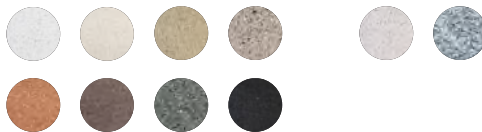

FINISHING / FINITURE / ACABADOS / FINITIONS:



ACCESSORIES / ACCESSORI / ACCESORIOS / ACCESSOIRES:





7

7

4







ROGER

DEL PONTE, ZAMBELLI



L 449 mm
W 450 mm
H 847 mm
65 kg

MATERIALS / MATERIALI / MATERIALES / MATÉRIAUX:
ULTRATENSE CONCRETE®



FINISHING / FINITURE / ACABADOS / FINITIONS:



ACCESSORIES / ACCESSORI / ACCESORIOS / ACCESSOIRES:



















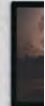

SPRING

DEL PONTE, ZAMBELLI



L 449 mm
W 450 mm
H 450 mm
54 kg

MATERIALS / MATERIALI / MATERIALES / MATÉRIAUX:

ULTRATENSE CONCRETE®



FINISHING / FINITURE / ACABADOS / FINITIONS:



ACCESSORIES / ACCESSORI / ACCESORIOS / ACCESSOIRES:





TEQBALL



PINGPONG



SCACCHI

GAME COLLECTION



LAVAGNA



TEQBALL

BELLITALIA DESIGN

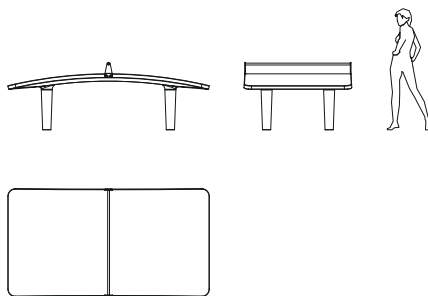

L 3000 mm
W 1500 mm
H 900 mm
h 760 mm
928 kg

MATERIALS / MATERIALI / MATERIALES / MATÉRIAUX:

HIGHTENSE CONCRETE

POWDER COATED STEEL
ACCIAIO VERNICIATO
ACERO PINTADO
ACIER THERMOLAQUÉ



FINISHING / FINITURE / ACABADOS / FINITIONS:



ACCESSORIES / ACCESSORI / ACCESORIOS / ACCESSOIRES:





TEQBALL

BELLITALIA DESIGN





PINGPONG

BELLITALIA DESIGN

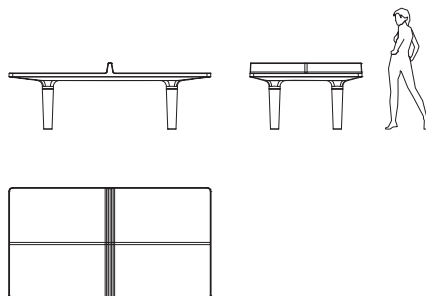

L 2740 mm
W 1525 mm
H 900 mm
h 760 mm
1209 kg

MATERIALS / MATERIALI / MATERIALES / MATÉRIAUX:

POWDER COATED STEEL
ACCIAIO VERNICIATO
ACERO PINTADO
ACIER THERMOLAQUÉ

HIGHTENSE CONCRETE



FINISHING / FINITURE / ACABADOS / FINITIONS:



ACCESSORIES / ACCESSORI / ACCESORIOS / ACCESSOIRES:





PINGPONG

BELLITALIA DESIGN









SCACCHI

BELLITALIA DESIGN

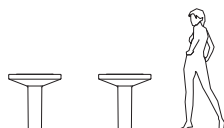

L 713 mm
W 713 mm
H 750 mm
180 kg

MATERIALS / MATERIALI / MATERIALES / MATÉRIAUX:

PIETRE PREZIOSE

GRANITO



FINISHING / FINITURE / ACABADOS / FINITIONS:



ACCESSORIES / ACCESSORI / ACCESORIOS / ACCESSOIRES:





SCACCHI

BELLITALIA DESIGN





LAVAGNA

MASSIMO TASCA

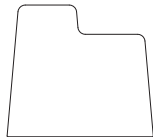

L 2000 mm
W 160 mm
H 1800 mm
h 1400 mm
960 kg



MATERIALS / MATERIALI / MATERIALES / MATÉRIAUX:
HIGHTENSE CONCRETE



FINISHING / FINITURE / ACABADOS / FINITIONS:







PIANETI COLLECTION



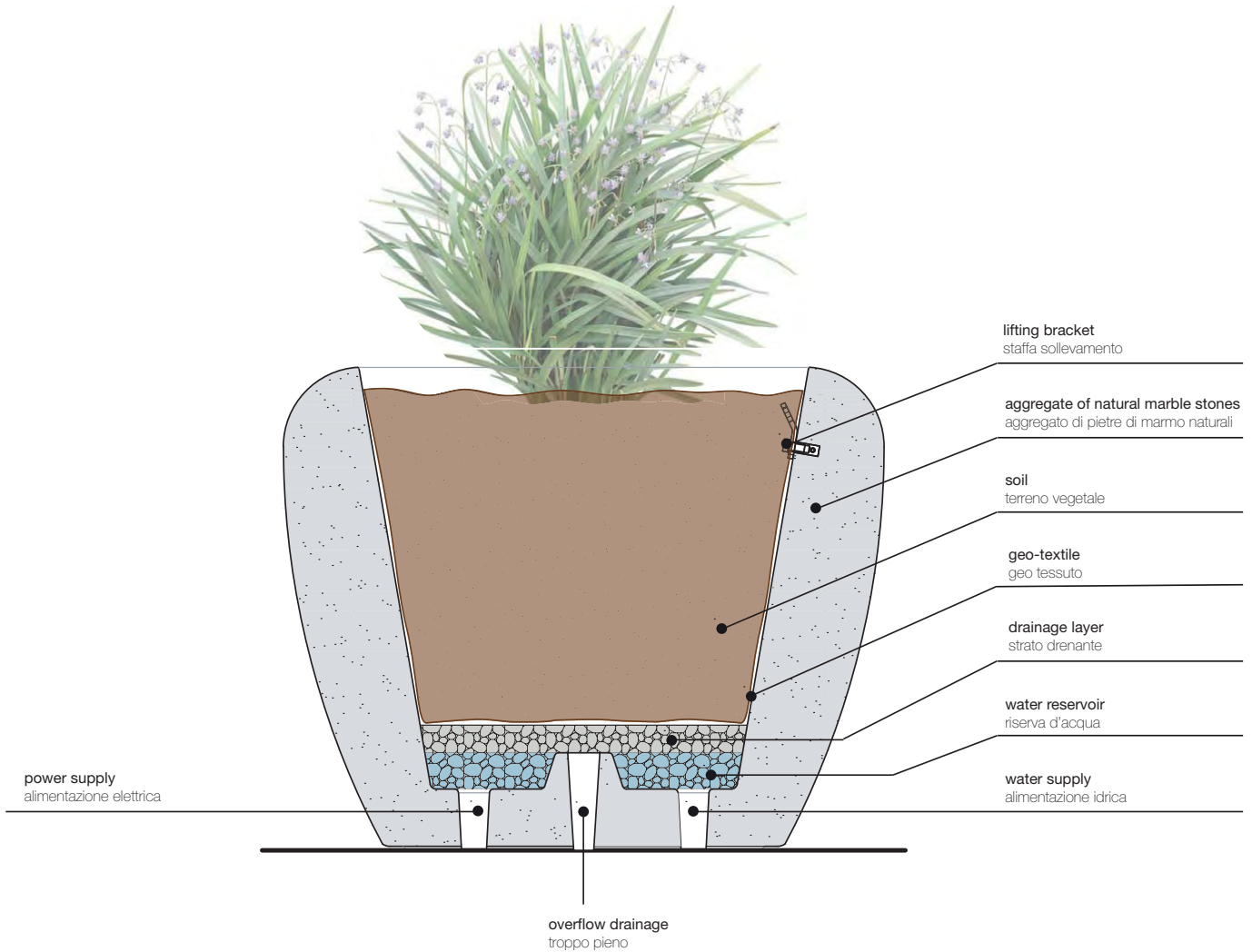

The planters of the collection PLANETI are equipped with water reserve system (except Marte*), overflow discharge and hole for passage electrical and/ or hydraulic systems. Each planter is equipped with three brackets for handling with bands or chains.

Le fioriere della collezione PLANETI sono dotate di sistema di riserva d'acqua (eccetto Marte*), scarico del troppo pieno e foro per passaggio impianti elettrici e/o idraulici. Ogni fioriera è dotata di tre staffe per la movimentazione con fasce o catene.

Las jardineras de la colección PLANETI están equipadas con sistema de reserva de agua (excepto Marte*), desagüe rebosadero y orificio para paso de instalaciones eléctricas y/o de fontanería. Cada jardinera está equipada con tres soportes para manipulación con cintas o cadenas.

Les jardinières de la collection PLANETI sont équipées d'un système de réserve d'eau (sauf Marte*), d'une décharge de trop-plein et d'un trou pour les installations électriques et/ou hydrauliques. Chaque jardinière est équipée de trois supports pour la manipulation avec des bandes ou des chaînes.



PIANETI

BELLITALIA DESIGN

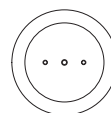
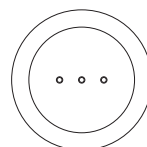
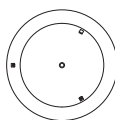

LUNA*

Ø 830 mm
H 520 mm
360 kg
85 lt

VENERE*

Ø 1153 mm
H 590 mm
800 kg
172 lt

GIOVE*

Ø 1500 mm
H 735 mm
1500 kg
489 lt

MARTE

Ø 1900 mm
H 1100 mm
3005 kg
1.212 lt

SATURNO*

Ø 1495 mm
H 1198 mm
2393 kg
805 lt

MATERIALS / MATERIALI / MATERIALES / MATÉRIAUX:

PIETRE PREZIOSE

GRANITO



FINISHING / FINITURE / ACABADOS / FINITIONS:



ACCESSORIES / ACCESSORI / ACCESORIOS / ACCESSOIRES:

















PIANETI CE

with Mura



COLLECTION

ano Glass



PIANETI with Murano Glass



The area in which Venice stands has always been the point of arrival of all maritime trade with the eastern coasts of the Mediterranean and glass has always enjoyed a central role.

The Venetian glassmakers of Murano Island, had a real development around the X century, sensing the malleability of glass and its ability to be blown and modelled in the incandescent state, but capable of maintaining the same chromatic characteristics. From the XIX century, the Murano glassworks began to develop new techniques, still in use today, pushing glass processing towards contemporary art and product design. The magic of Murano glass is contained in its own secret island, which has kept the industrial secrets for centuries, creating unique products in the world.

L'area in cui sorge Venezia è sempre stata il punto di arrivo di tutti gli scambi marittimi con le coste orientali del Mediterraneo e il vetro in particolare, ha sempre goduto di un ruolo centrale.

I vetrai Veneziani dell'isola di Murano ebbero un vero e proprio sviluppo a partire dal X secolo, intuendo la malleabilità del vetro e la sua capacità di essere soffiato e modellato allo stato incandescente, ma capace di mantenere le stesse caratteristiche cromatiche.

Dal XIX secolo i vetrai di Murano iniziarono ad elaborare nuove tecniche, tutt'oggi in uso, spingendo la lavorazione del vetro verso l'arte contemporanea e il product design. La magia del vetro di Murano è racchiusa nella sua stessa isola, che custodisce da secoli i segreti industriali di un prodotto unico al mondo.

La zona en la que se encuentra Venecia siempre ha sido el punto de llegada de todos los intercambios marítimos con las costas orientales del Mediterráneo y el vidrio en particular, siempre ha tenido un papel central.

Los vidrieros venecianos de la isla de Murano tuvieron un gran desarrollo a partir del siglo X, intuendo la maleabilidad del vidrio y su capacidad para ser soplado y modelado en estado incandescente, pero capaz de mantener las mismas características cromáticas.

A partir del siglo XIX, los vidrieros de Murano comenzaron a desarrollar nuevas técnicas, aún en uso hoy en día, empujando el procesamiento del vidrio hacia el arte y el diseño de productos contemporáneos. La magia del cristal de Murano está contenida en su propia isla, que durante siglos ha guardado los secretos industriales de un producto único en el mundo.

La région où se trouve Venise a toujours été le point d'arrivée de tous les échanges maritimes avec les côtes orientales de la Méditerranée et le verre en particulier a toujours joué un rôle central.

Les verriers vénitiens de l'île de Murano ont connu un véritable développement à partir du Xe siècle, sentant la malléabilité du verre et sa capacité à être soufflé et façonné à l'état incandescent, mais capable de conserver les mêmes caractéristiques chromatiques.

À partir du XIXe siècle, les verriers de Murano ont commencé à élaborer de nouvelles techniques, encore utilisées aujourd'hui, poussant le travail du verre vers l'art contemporain et le design produit. La magie du verre de Murano est contenue dans son île, qui conserve depuis des siècles les secrets industriels d'un produit unique au monde.



PIANETI with Murano Glass



Bellitalia® has chosen to collaborate with a trusted partner, Ekonya, to create the planters of the PIANETI collection with an eco-sustainable cement mixture containing aggregates of various colors, obtained from the recovery of Murano glass processing. Ekonia values environmental sustainability and aesthetics. Therefore, it uses binders in its concrete from the dust of semi-finished products from the cast iron industry, a choice that considerably reduces their environmental impact. The production process replicates the natural rock formation process with innovative industrial technology, creating a product whose technical properties equal those of Portland cement. In 2020, the company was selected as one of the best European startups contributing to reduce climate change.

Bellitalia® ha scelto di collaborare con un partner di fiducia, Ekonia, per realizzare le fioriere della collezione PIANETI con un conglomerato cementizio ecosostenibile contenente inerti, di vari colori, ottenuti dal recupero della lavorazione del vetro di Murano. Ekonia ha come valori la sostenibilità ambientale e l'estetica. Per questo, nel suo calcestruzzo, utilizza leganti provenienti dalle polveri dei semilavorati dell'industria della ghisa, scelta che riduce in modo considerevole il loro impatto ambientale. Il processo produttivo replica il processo di formazione naturale della roccia, con un'innovativa tecnologia industriale, creando però un prodotto le cui qualità tecniche eguagliano quelle del cemento Portland. Nel 2020 la società è stata selezionata tra le migliori startup europee che contribuiscono a ridurre i cambiamenti climatici.

Bellitalia® ha elegido colaborar con un colaborador de confianza, Ekonia, para realizar los floreros de la colección PIANETI con un hormigón ecosostenible, que contiene áridos de varios colores, obtenidos a partir de la recuperación del labrado del vidrio de Murano. Los valores de Ekonia son la sostenibilidad ambiental y la estética. Por esto, en su hormigón, utiliza aglutinantes procedentes de polvos de productos semimanufacturados de la industria de la fundición, una elección que reduce enormemente su impacto ambiental. El proceso de producción replica el proceso de formación natural de la roca, a través de una tecnología innovadora industrial, pero creando un producto con cualidades técnicas iguales a las del cemento Portland. En 2020, la sociedad fue seleccionada una de las mejores startups europeas, que contribuyen a reducir los cambios climáticos.

Bellitalia® a choisi Ekonia, un partenaire de confiance, pour réaliser les jardinières de la collection PIANETI avec un conglomerat cimenté écologique se composant de granulats inertes, de plusieurs couleurs, provenant de la récupération de traitement de verre de Murano. Les valeurs de Ekonia sont la durabilité environnementale et l'esthétisme. C'est pour cela que l'entreprise utilise pour son béton des liants provenant de poudres de produits semi-finis issus de l'industrie de la fonte, un choix qui réduit considérablement l'impact environnemental. Le processus de production reproduit le processus de formation naturelle de la roche, par une technologie industrielle innovante, en créant toutefois un produit dont les qualités techniques égalent celles du ciment Portland. En 2020, la société a été sélectionnée parmi les meilleures startups européennes qui contribuent à réduire les changements climatiques.







MARTE with Murano Glass



GIOVE with Murano Glass

Murano Bianco



Murano Grigio

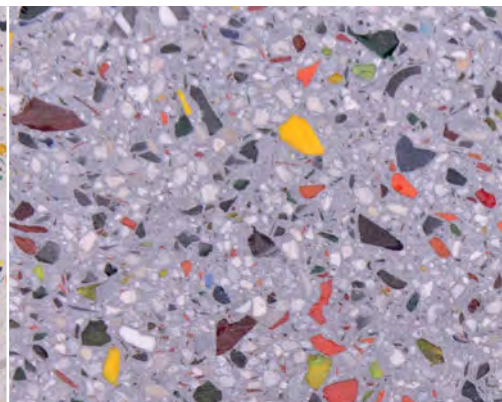



VENERE with Murano Glass



LUNA with Murano Glass

PIANETI with Murano Glass

Murano Antracite

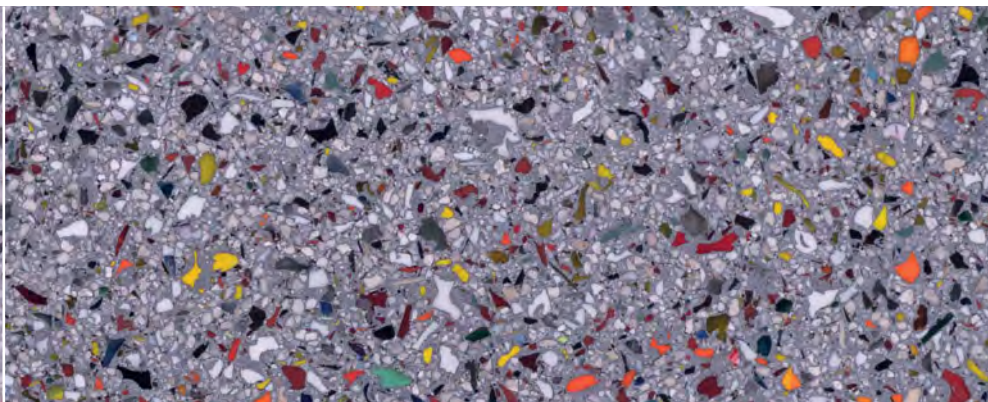
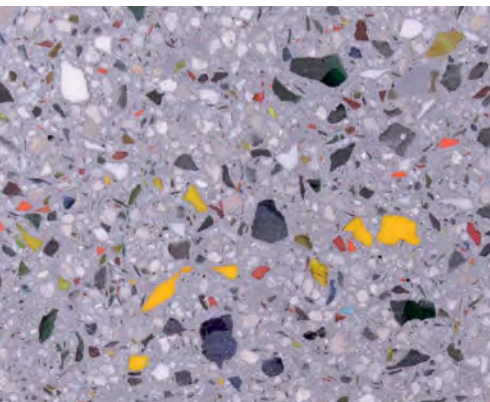



CLIMB

IVANO DESIGN

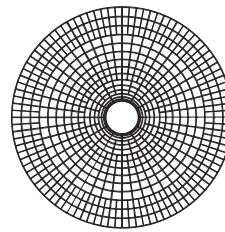
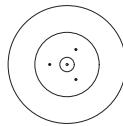
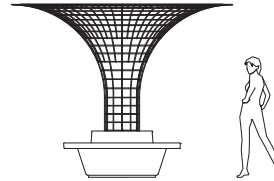
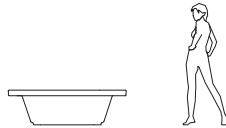

Ø 1700 mm
H 500 mm
900 kg
250 lt

Ø 3390 mm
H 2520 mm
1070 kg
320 lt

MATERIALS / MATERIALI / MATERIALES / MATÉRIAUX:

PIETRE PREZIOSE

GRANITO



FINISHING / FINITURE / ACABADOS / FINITIONS:



ACCESSORIES / ACCESSORI / ACCESORIOS / ACCESSOIRES:









CLIMB

IVANO DESIGN







ALONE COLLECTION



TALL - LOW

BELLITALIA DESIGN



TALL

L 600 mm
W 600 mm
H 1000 mm
477 kg
140 lt

LOW

L 1000 mm
W 800 mm
H 600 mm
521 kg
214 lt

MATERIALS / MATERIALI / MATERIALES / MATÉRIAUX:

PIETRE PREZIOSE

GRANITO



FINISHING / FINITURE / ACABADOS / FINITIONS:



ACCESSORIES / ACCESSORI / ACCESORIOS / ACCESSOIRES:





MIDNIGHT
COOKERY 0208 450 0727

8 D

7

6

TALL - LOW

BELLITALIA DESIGN





ORIONE - PEGASO

BELLITALIA DESIGN

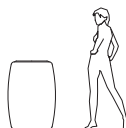

ORIONE

Ø 520 mm
H 816 mm
242 kg
13 lt

PEGASO

Ø 640 mm
H 912 mm
374 kg
26 lt



MATERIALS / MATERIALI / MATERIALES / MATÉRIAUX:

PIETRE PREZIOSE

GRANITO



FINISHING / FINITURE / ACABADOS / FINITIONS:



ACCESSORIES / ACCESSORI / ACCESORIOS / ACCESSOIRES:





LONG - SHORT

BELLITALIA DESIGN

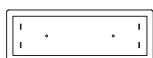

LONG

L 1980 mm
W 700 mm
H 600 mm
660 kg
483 lt

SHORT

L 1500 mm
W 800 mm
H 650 mm
850 kg
437 lt

MATERIALS / MATERIALI / MATERIALES / MATÉRIAUX:

PIETRE PREZIOSE

GRANITO



FINISHING / FINITURE / ACABADOS / FINITIONS:



ACCESSORIES / ACCESSORI / ACCESORIOS / ACCESSOIRES:









LONG - SHORT

BELLITALIA DESIGN





BERRY

BELLITALIA DESIGN

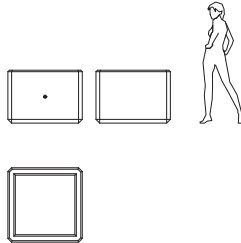

L 1000 mm
W 1000 mm
H 711 mm
760 kg
391 lt



MATERIALS / MATERIALI / MATERIALES / MATÉRIAUX:
PIETRE PREZIOSE GRANITO

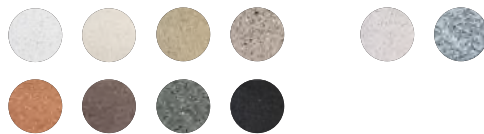

FINISHING / FINITURE / ACABADOS / FINITIONS:

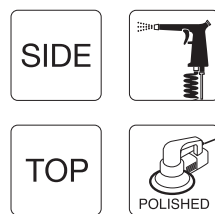

ACCESSORIES / ACCESSORI / ACCESORIOS / ACCESSOIRES:





CORVARA

BELLITALIA DESIGN

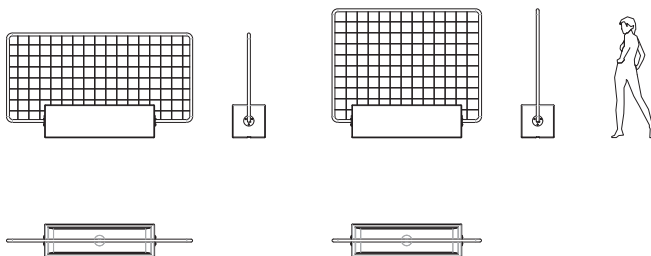

L 2540 mm
I 1500 mm
W 450 mm
H 1430 mm
325 kg
170 lt

L 2040 mm
I 1500 mm
W 450 mm
H 1760 mm
325 kg
170 lt

MATERIALS / MATERIALI / MATERIALES / MATÉRIAUX:

PIETRE PREZIOSE



GRANITO



POWDER COATED STEEL
ACCIAIO VERNICIATO
ACERO PINTADO
ACIER THERMOLAQUÉ



FINISHING / FINITURE / ACABADOS / FINITIONS:



RAL

ACCESSORIES / ACCESSORI / ACCESORIOS / ACCESSOIRES:









COROLLA

BELLITALIA DESIGN

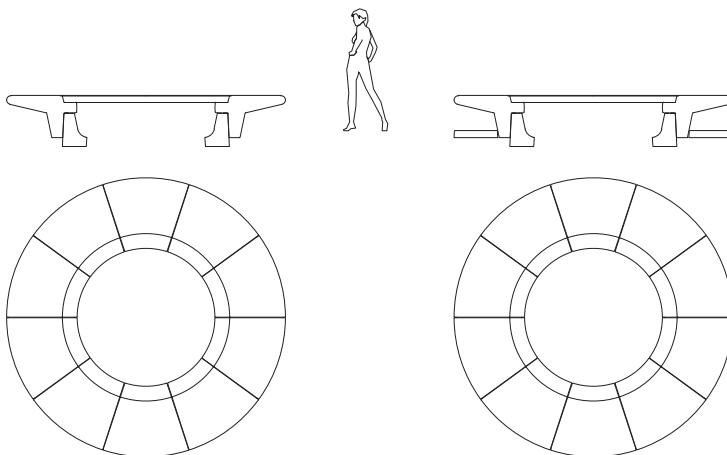

Ø 4000 mm
H 500 mm
7585 kg
1.594 lt

Ø 4000 mm
H 500 mm
9005 kg
1.594 lt

MATERIALS / MATERIALI / MATERIALES / MATÉRIAUX:

PIETRE PREZIOSE

GRANITO



FINISHING / FINITURE / ACABADOS / FINITIONS:



ACCESSORIES / ACCESSORI / ACCESORIOS / ACCESSOIRES:









CASSIOPEA

BELLITALIA DESIGN

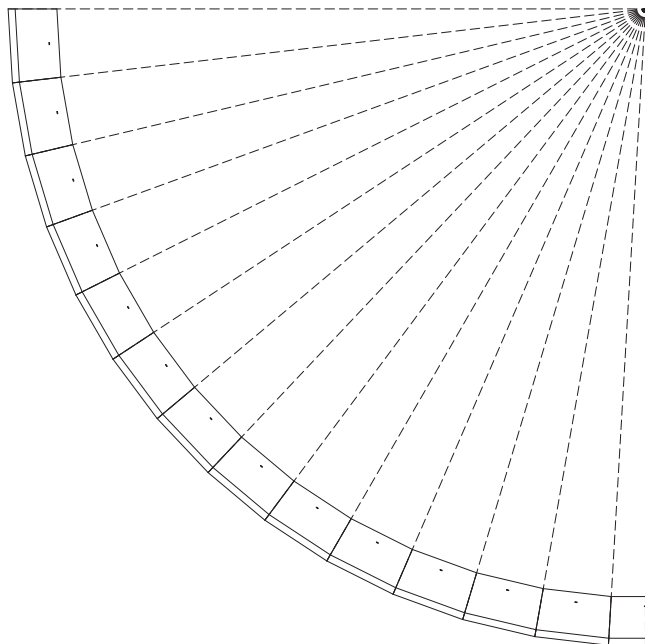
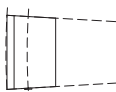
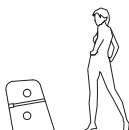

Ri 7790 mm
 Re 8430 mm
 L 979 mm
 W 644 mm
 H 675 mm
 750 kg
 12.850 lt

MATERIALS / MATERIALI / MATERIALES / MATÉRIAUX:

PIETRE PREZIOSE

GRANITO



FINISHING / FINITURE / ACABADOS / FINITIONS:



ACCESSORIES / ACCESSORI / ACCESORIOS / ACCESSOIRES:









A close-up, black and white photograph of a perforated metal grill. The grill is covered in numerous small, glistening water droplets. The background is dark, and a diagonal line of light is visible in the upper left corner. The text "TREE GRILLS COLLECTION" is centered in the middle of the image.

TREE GRILLS COLLECTION

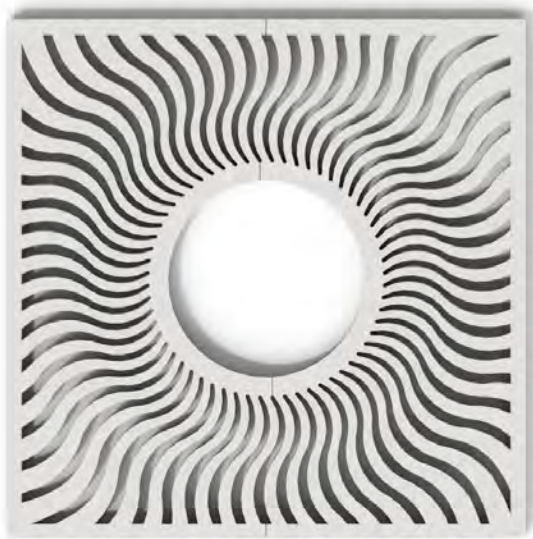

SOLAR - SOLAR SQUARE

C + S ARCHITECTS

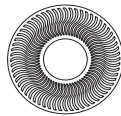

SOLAR

Ø 1452 mm
Ø 560 mm
H 40 mm
108 kg

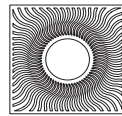

SOLAR SQUARE

L 1452 mm
Ø 560 mm
H 40 mm
142 kg



MATERIALS / MATERIALI / MATERIALES / MATÉRIAUX:

ULTRATENSE CONCRETE®



FINISHING / FINITURE / ACABADOS / FINITIONS:



ACCESSORIES / ACCESSORI / ACCESORIOS / ACCESSOIRES:





CIRCLE

C + S ARCHITECTS

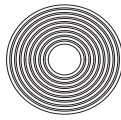
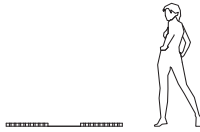

Ø 1452 mm
Ø 400 mm
H 40 mm
122 kg

MATERIALS / MATERIALI / MATERIALES / MATÉRIAUX:

ULTRATENSE CONCRETE®



FINISHING / FINITURE / ACABADOS / FINITIONS:



ACCESSORIES / ACCESSORI / ACCESORIOS / ACCESSOIRES:



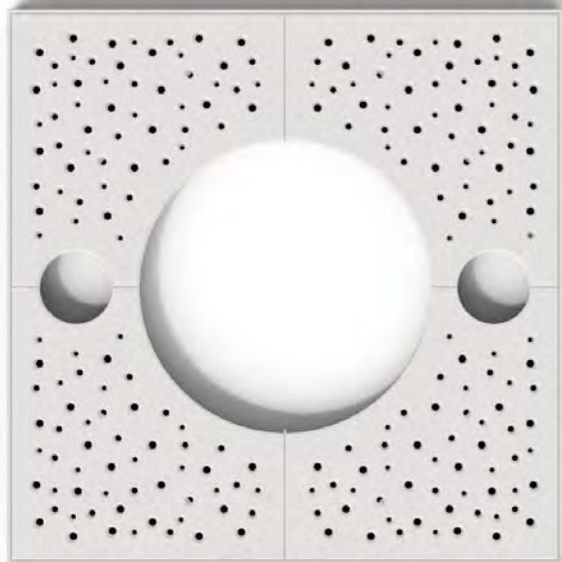
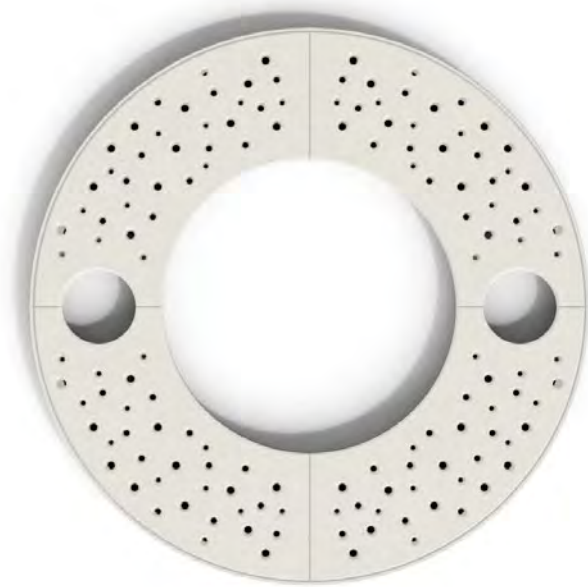

BUBBLE - BUBBLE SQUARE

BELLITALIA DESIGN

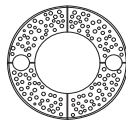

BUBBLE L

Ø 1524 mm
Ø 800 mm
H 64 mm
119 kg

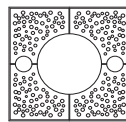

BUBBLE SQUARE L

L 1520 mm
Ø 800 mm
H 64 mm
136 kg

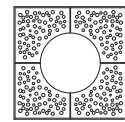

BUBBLE SQUARE

L 1520 mm
Ø 800 mm
H 64 mm
136 kg



MATERIALS / MATERIALI / MATERIALES / MATÉRIAUX:

ULTRATENSE CONCRETE®



FINISHING / FINITURE / ACABADOS / FINITIONS:



ACCESSORIES / ACCESSORI / ACCESORIOS / ACCESSOIRES:



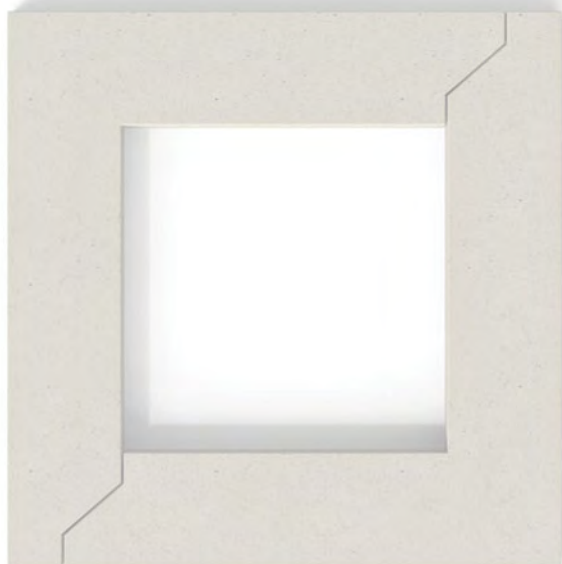

DIAGO

BELLITALIA DESIGN

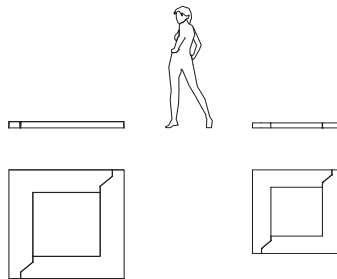

L 1500 mm
W 1500 mm
l 874 mm
w 877 mm
H 80 mm
325 kg

L 1200 mm
W 1200 mm
l 690 mm
w 700 mm
H 70 mm
190 kg

MATERIALS / MATERIALI / MATERIALES / MATÉRIAUX:

PIETRE PREZIOSE

GRANITO

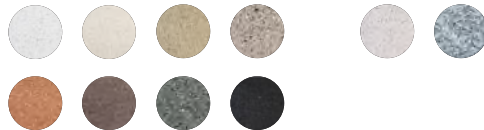

FINISHING / FINITURE / ACABADOS / FINITIONS:



ACCESSORIES / ACCESSORI / ACCESORIOS / ACCESSOIRES:

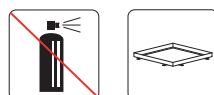













BOLLARDS COLLECTION



BOSTON

BELLITALIA DESIGN



L 270 mm
I 250 mm
H 700 mm
40 kg

MATERIALS / MATERIALI / MATERIALES / MATÉRIAUX:

PIETRE PREZIOSE

GRANITO



FINISHING / FINITURE / ACABADOS / FINITIONS:



ACCESSORIES / ACCESSORI / ACCESORIOS / ACCESSOIRES:





KONE - TRONCO

ALFREDO TASCA

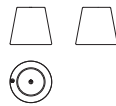
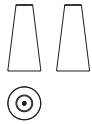

KONE

Ø 400 mm
Ø 200 mm
H 800 mm
107 kg

TRONCO

Ø 300 mm
Ø 450 mm
H 400 mm
140 kg



MATERIALS / MATERIALI / MATERIALES / MATÉRIAUX:

PIETRE PREZIOSE

GRANITO

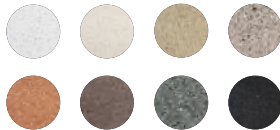

FINISHING / FINITURE / ACABADOS / FINITIONS:



ACCESSORIES / ACCESSORI / ACCESORIOS / ACCESSOIRES:





NY

BELLITALIA DESIGN

**NY A**

B 411 mm
b 138 mm
H 1000 mm
110 kg

NY AP

B 411 mm
b 138 mm
H 1000 mm
83 kg

NY B *

B 411 mm
b 274 mm
H 500 mm
61 kg

**MATERIALS / MATERIALI / MATERIALES / MATÉRIAUX:**

PIETRE PREZIOSE

GRANITO

**FINISHING / FINITURE / ACABADOS / FINITIONS:****ACCESSORIES / ACCESSORI / ACCESORIOS / ACCESSOIRES:**



DENZ

MASSIMO TASCA



L 210 mm
W 135mm
H 500 mm
58 kg



MATERIALS / MATERIALI / MATERIALES / MATÉRIAUX:

PIETRE PREZIOSE

GRANITO



FINISHING / FINITURE / ACABADOS / FINITIONS:



ACCESSORIES / ACCESSORI / ACCESORIOS / ACCESSOIRES:





SFERA

BELLITALIA DESIGN



Ø 300 mm
H 283 mm
37 kg

Ø 400 mm
H 377 mm
83 kg

Ø 500 mm
H 471 mm
161 kg

MATERIALS / MATERIALI / MATERIALES / MATÉRIAUX:

PIETRE PREZIOSE

GRANITO



FINISHING / FINITURE / ACABADOS / FINITIONS:



ACCESSORIES / ACCESSORI / ACCESORIOS / ACCESSOIRES:





PLUTONE

BELLITALIA DESIGN



Ø 400 mm
H 704 mm
165 kg



MATERIALS / MATERIALI / MATERIALES / MATÉRIAUX:

PIETRE PREZIOSE

GRANITO



FINISHING / FINITURE / ACABADOS / FINITIONS:



ACCESSORIES / ACCESSORI / ACCESORIOS / ACCESSOIRES:





OBELIX

BELLITALIA DESIGN

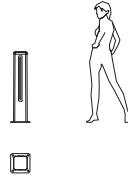

L 280 mm
W 280 mm
H 2300 mm
202 kg

L 280 mm
W 280 mm
H 1000 mm
96 kg



MATERIALS / MATERIALI / MATERIALES / MATÉRIAUX:

PIETRE PREZIOSE

GRANITO

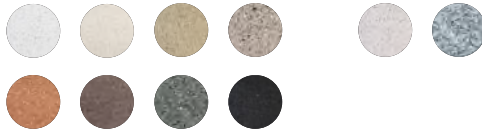

FINISHING / FINITURE / ACABADOS / FINITIONS:



ACCESSORIES / ACCESSORI / ACCESORIOS / ACCESSOIRES:





T-BIKE & T-BOX

MASSIMO TASCA

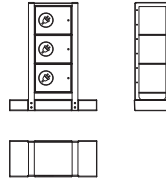
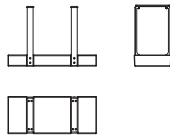

T-BIKE

L 1200 mm
W 500 mm
H 805 mm
240 kg

T-BOX

L 1200 mm
W 500 mm
H 1500 mm
355 kg



MATERIALS / MATERIALI / MATERIALES / MATÉRIAUX:

PIETRE PREZIOSE



GRANITO



POWDER COATED STEEL
ACCIAIO VERNICIATO
ACERO PINTADO
ACIER THERMOLAQUÉ



FINISHING / FINITURE / ACABADOS / FINITIONS:



RAL

ACCESSORIES / ACCESSORI / ACCESORIOS / ACCESSOIRES:





UP DOWN

BELLITALIA DESIGN

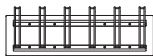
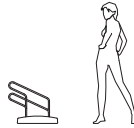

L 2000 mm
W 667 mm
H 567 mm
246 kg



MATERIALS / MATERIALI / MATERIALES / MATÉRIAUX:

PIETRE PREZIOSE



GRANITO



POWDER COATED STEEL
ACCIAIO VERNICIATO
ACERO PINTADO
ACIER THERMOLAQUÉ



FINISHING / FINITURE / ACABADOS / FINITIONS:



RAL

ACCESSORIES / ACCESSORI / ACCESORIOS / ACCESSOIRES:





PLASTICA / PLASTIC

CARTA / PAPER

RIFIUTI / WASTE



**LITTER BINS & CIGARETTE BINS
COLLECTION**



ROLLE

BELLITALIA DESIGN

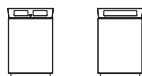

L 622 mm
W 622 mm
H 935 mm
360 kg

MATERIALS / MATERIALI / MATERIALES / MATÉRIAUX:

PIETRE PREZIOSE



GRANITO



POWDER COATED STEEL
ACCIAIO VERNICIATO
ACERO PINTADO
ACIER THERMOLAQUÉ



FINISHING / FINITURE / ACABADOS / FINITIONS:



RAL

INOX

ACCESSORIES / ACCESSORI / ACCESORIOS / ACCESSOIRES:





ROLLE

BELLITALIA DESIGN





TRI

MASSIMO TASCA, MATTIA LI POMI



L 1100 mm
W 500 mm
H 1100 mm
405 kg
180 lt

MATERIALS / MATERIALI / MATERIALES / MATÉRIAUX:

PIETRE PREZIOSE

GRANITO

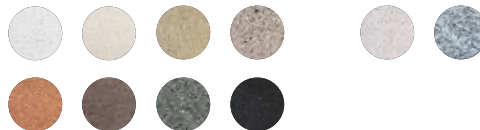

FINISHING / FINITURE / ACABADOS / FINITIONS:



ACCESSORIES / ACCESSORI / ACCESORIOS / ACCESSOIRES:





QU

MASSIMO TASCA, MATTIA LI POMI

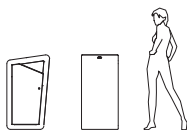

L 582 mm
W 500 mm
H 1000 mm
240 kg
120 lt



MATERIALS / MATERIALI / MATERIALES / MATÉRIAUX:

PIETRE PREZIOSE



GRANITO



POWDER COATED STEEL
ACCIAIO VERNICIATO
ACERO PINTADO
ACIER THERMOLAQUÉ



FINISHING / FINITURE / ACABADOS / FINITIONS:



RAL

INOX

ACCESSORIES / ACCESSORI / ACCESORIOS / ACCESSOIRES:









INTERSECTION

MENEGHELLO PAOLELLI ASSOCIATI

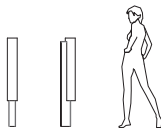

L 121 mm
W 176 mm
H 1030 mm
28 kg

MATERIALS / MATERIALI / MATERIALES / MATÉRIAUX:

PIETRE PREZIOSE



GRANITO



POWDER COATED STEEL
ACCIAIO VERNICIATO
ACERO PINTADO
ACIER THERMOLAQUÉ



FINISHING / FINITURE / ACABADOS / FINITIONS:



RAL

INOX

ACCESSORIES / ACCESSORI / ACCESORIOS / ACCESSOIRES:









ORIONE SC - CC

BELLITALIA DESIGN

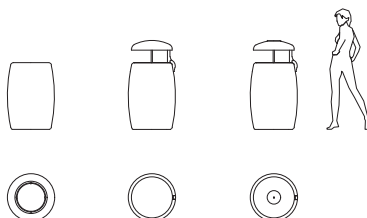

Ø 520 mm
H 816 / 1051 mm
242 / 248 kg
56 lt

MATERIALS / MATERIALI / MATERIALES / MATÉRIAUX:

PIETRE PREZIOSE



GRANITO



POWDER COATED STEEL
ACCIAIO VERNICIATO
ACERO PINTADO
ACIER THERMOLAQUÉ



FINISHING / FINITURE / ACABADOS / FINITIONS:



ACCESSORIES / ACCESSORI / ACCESORIOS / ACCESSOIRES:





PEGASO SC - CC

BELLITALIA DESIGN

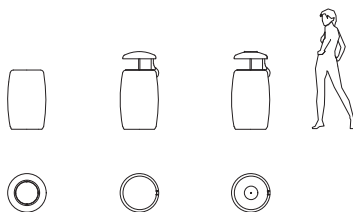

Ø 640 mm
H 912 / 1200 mm
374 / 383 kg
104 lt

MATERIALS / MATERIALI / MATERIALES / MATÉRIAUX:

PIETRE PREZIOSE



GRANITO



POWDER COATED STEEL
ACCIAIO VERNICIATO
ACERO PINTADO
ACIER THERMOLAQUÉ



FINISHING / FINITURE / ACABADOS / FINITIONS:



ACCESSORIES / ACCESSORI / ACCESORIOS / ACCESSOIRES:





SQUARE

BELLITALIA DESIGN

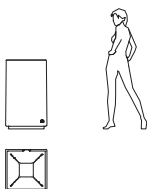

L 600 mm
W 600 mm
H 1000 mm
490 kg
64 lt

MATERIALS / MATERIALI / MATERIALES / MATÉRIAUX:

PIETRE PREZIOSE



GRANITO



POWDER COATED STEEL
ACCIAIO VERNICIATO
ACERO PINTADO
ACIER THERMOLAQUÉ



FINISHING / FINITURE / ACABADOS / FINITIONS:



RAL

INOX

ACCESSORIES / ACCESSORI / ACCESORIOS / ACCESSOIRES:



RUPERT EVERETT COLIN FIRTH COLIN MORGAN EDWIN THOMAS EMILY WATSON TOM WILKINSON

EUROARTE
65
L'Espresso

SCRITTO E DIRETTO DA RUPERT EVERETT

THE HAPPY PRINCE
L'ULTIMO RITRATTO DI OSCAR WILDE

EUROARTE
65
L'Espresso

www.happyprincefilm.com

DAL 12 APRILE AL CINEMA



TOTÒ

MASSIMO TASCA

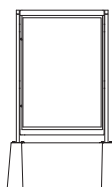

L 1042 mm
W 280 mm
H 2253 mm
440 kg

MATERIALS / MATERIALI / MATERIALES / MATÉRIAUX:

PIETRE PREZIOSE



GRANITO



POWDER COATED STEEL
ACCIAIO VERNICIATO
ACERO PINTADO
ACIER THERMOLAQUÉ



FINISHING / FINITURE / ACABADOS / FINITIONS:



ACCESSORIES / ACCESSORI / ACCESORIOS / ACCESSOIRES:





NEW STEP-UP COURSE
THE SPECIAL FOR THE BEST OF BOTH WORLDS



SPINOLTA | MONALDI



ECCARDIOGRAFIA
MONALDI
2018
HOW TO INTO NEW
ECHO-TECHNOLOGIES
AND THERAPIES
PRACTICAL APPROACH
TO NEW SYSTEMS

V: 

14-15-16
NOVEMBRE
2018

Napoli
Organizzato da

Associazione
Pubblicazione
Biblioteca Cardiaci

Dirigente
Infermeria
Pia Casa





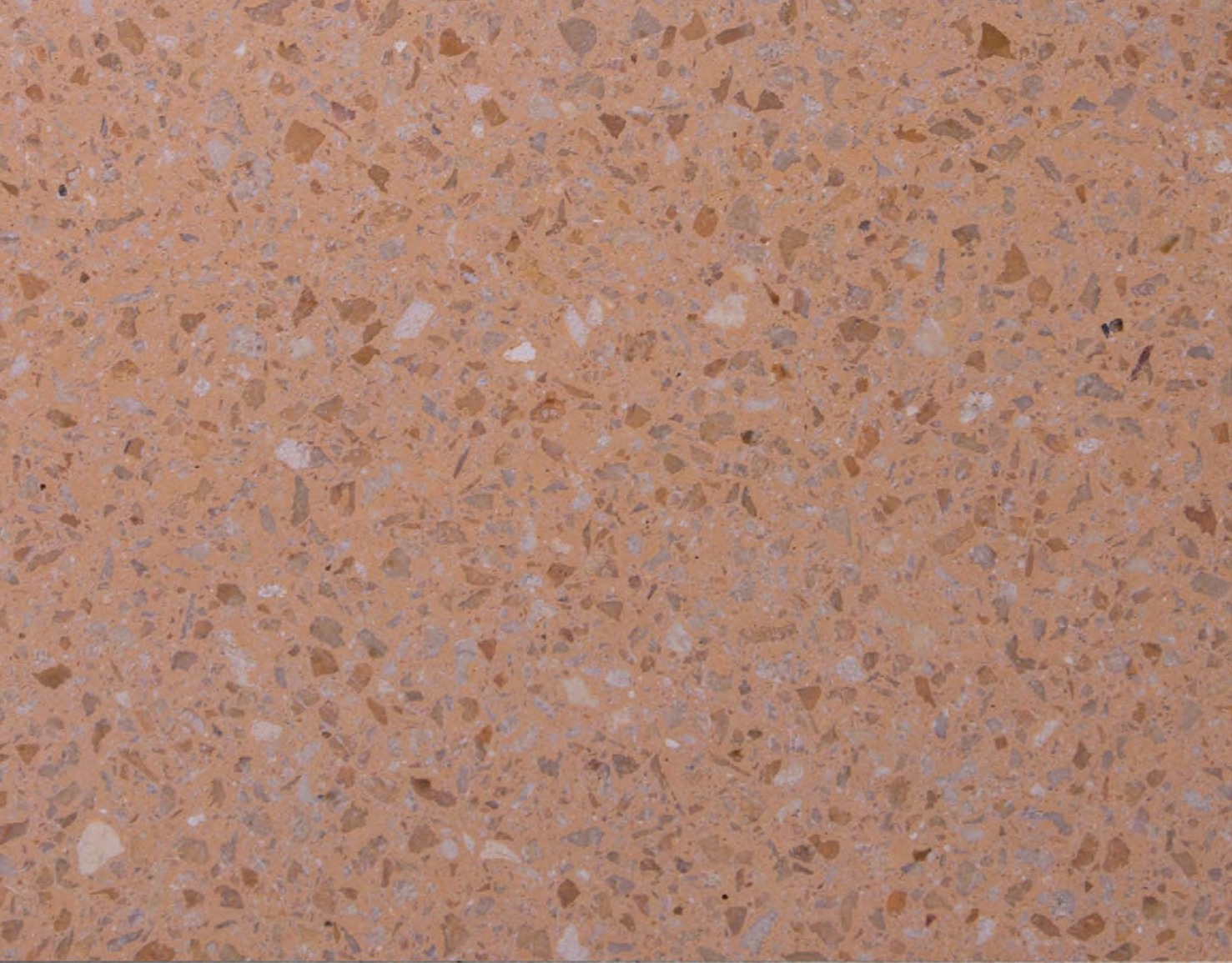



CONCRETE SLABS

LASTRE IN CEMENTO

LOSAS DE CONCRETO

DALLES DE BÉTON



puppinato
Provincia - Italy

t 2.5

SIMEC

SIMEC

NEW DEPARTMENT: CONCRETE SLABS
NUOVO REPARTO: LASTRE IN CEMENTO
NUEVO REPARTO: LOSAS EN CEMENTO
NOUVEAU DÉPARTEMENT: PLAQUES EN BÉTON

CONCRETE SLABS

Thanks to its in-depth and consolidated experience in working with concrete aggregates, Bellitalia produces slabs of different sizes and thicknesses for horizontal surfaces.

The slabs are available in polished, brushed or bush-hammered Precious Stones, in the colors listed on page 410 | 411.

The slabs in Precious Stones are made from a durable and elegant mixture of reinforced concrete with the addition of carefully selected stone or marble aggregates, available in different natural colors listed on page 410 | 411.

Bellitalia, grazie alla sua approfondita e consolidata esperienza nella lavorazione dei conglomerati cementizi, realizza lastre di diverse dimensioni e spessori per superfici orizzontali.

Le lastre sono disponibili in Pietre Preziose levigate, spazzolate o bocciardate nelle colorazioni disponibili elencate a pagina 410 | 411.

Le lastre in Pietre Preziose sono realizzate con una miscela resistente ed elegante di cemento rinforzato con l'aggiunta di inerti attentamente selezionati di pietre o marmo, disponibili in diverse colorazioni naturali a pagina 410 | 411.

Con su amplia y consolidada experiencia en el tratamiento de los cementos, Bellitalia realiza losas de varios tamaños y espesores para superficies horizontales.

Las losas están disponibles en piedras preciosas pulidas, trabajadas con púas rígidas o abujardadas, en los colores disponibles indicados en la página 410 | 411.

Las losas en piedras preciosas se realizan con una mezcla resistente y elegante de cemento reforzado con el añadido de áridos de piedras o mármol, meticulosamente seleccionados, disponibles en los varios colores naturales en página 410 | 411.

Grâce à son expérience approfondie et consolidée dans le traitement de conglomerats cimentés, Bellitalia réalise des plaques de plusieurs dimensions et épaisseurs pour des surfaces horizontales.

Ces plaques sont proposées en Pierres Précieuses lissée, brossée ou bouchardée, dans les couleurs figurant à la page 410 | 411.

Les plaques en Pierre Précieuses sont réalisées avec un mélange résistant et élégant de ciment et de matériaux inertes se composant de pierres ou de marbre, soigneusement sélectionnés et disponibles dans plusieurs couleurs naturelles figurant à la page 410 | 411.



SLABS FOR **HOSPITALITY**

Hospitality projects using 100x100 cm, 35 mm width, granito slabs with a polished, brushed or bush-hammered finish installed on adjustable feet.

Realizzazione in ambito hospitality utilizzando piastre formato 100x100 cm, spessore 35 mm circa, in granito con finitura levigata, spazzolata o bocciardata posizionate su piedini regolabili.

Realización en el ámbito hotelero utilizando losas con un formato de 100x100 cm y espesor de 35 mm, en granito y acabado pulido, trabajado con púas rígidas o abujardado, posicionadas sobre pies regulables.

Réalisation dans le secteur hôtelier en utilisant des plaques de 100x100 cm, largeur 35 mm, en granito avec une finition lisse, brossé ou bouchardé placées sur des pieds réglables.





SLABS FOR **PRIVATE SPACES**



Residential/Private spaces projects using 100x100 cm, 20 mm width, granito slabs with a polished, brushed or bush-hammered finish installed on a bed of sand and concrete.

Realizzazione in ambito privato utilizzando piastre formato 100x100 cm, spessore 20 mm, in granito con finitura levigata, spazzolata o bocciardata posizionate su letto di sabbia e cemento.

Realización en el ámbito particular/ privado utilizando losas con un formato de 100x100 cm y espesor de 20 mm, en granito y acabado pulido, trabajado con púas rígidas o abujardado, posicionadas en un lecho de arena y cemento.

Réalisation dans le secteur privé en utilisant des plaques de 100x100 cm, largeur 20 mm, en granito avec une finition lisse, brossé ou bouchardé positionnées sur un lit de sable et de ciment.



SLABS FOR **PUBLIC SPACES**



Public spaces projects using 100x100 cm, 20 mm width, granite slabs with a polished, brushed or bush-hammered finish installed on a bed of sand and concrete.

Realizzazione in ambito pubblico utilizzando piastre formato 100x100 cm, spessore 20 mm, in granito con finitura levigata, spazzolata o bocciardata posizionate su letto di sabbia e cemento.

Realización en el ámbito público utilizando losas con un formato de 100x100 cm y espesor de 20 mm, en granito y acabado pulido, trabajado con púas rígidas o abujardado, posicionadas en un lecho de arena y cemento.

Réalisation dans le secteur public en utilisant des plaques de 100x100 cm, largeur 20 mm, en granito avec une finition lisse, brossé ou bouchardé positionnées sur un lit de sable et de ciment.

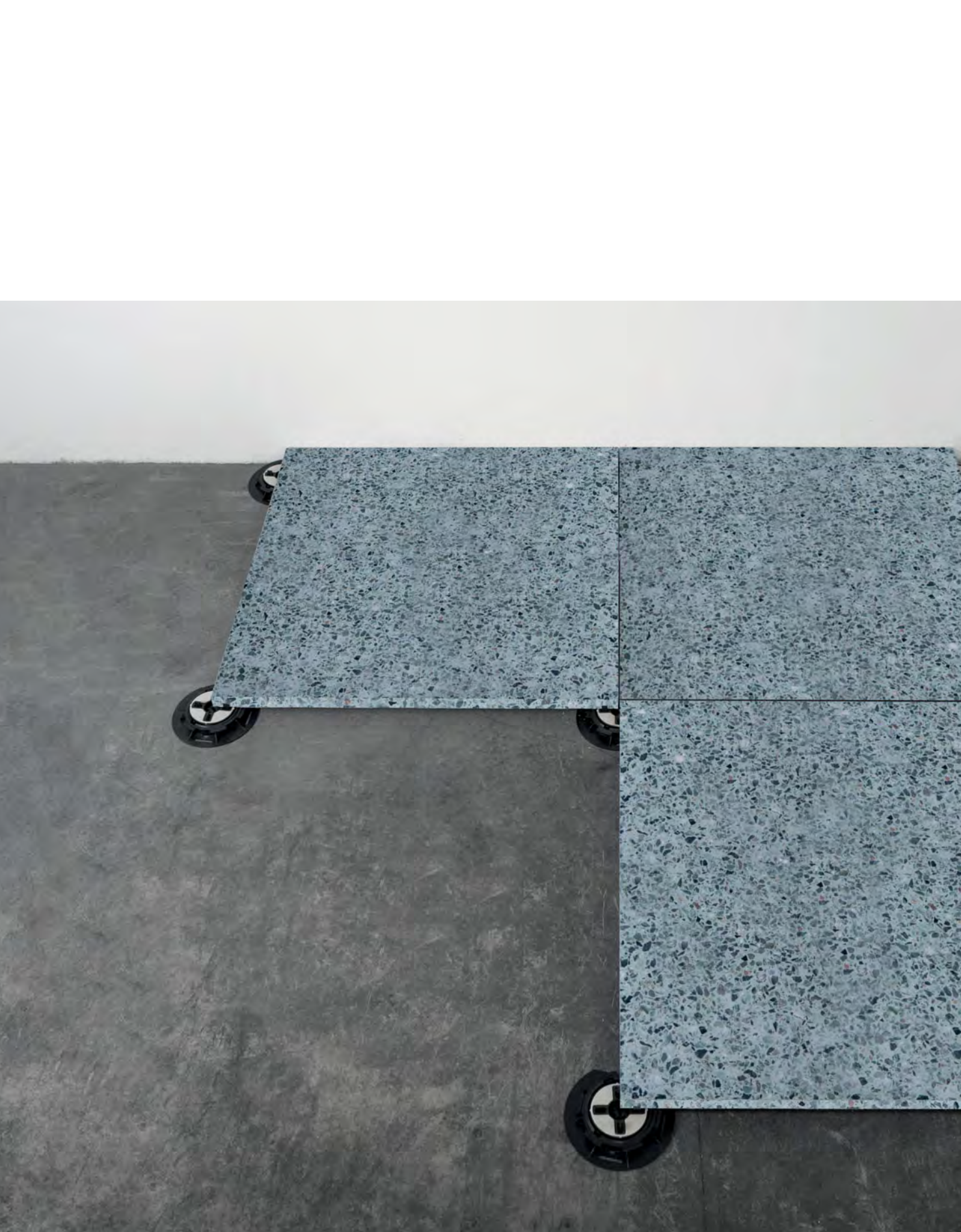

TECHNICAL FEATURES



These slabs are characterized by a textured appearance and have cloudy effects of uneven color with hairline cracks. This is because the different components that go into the concrete mix are extremely sensitive to environmental changes during the curing period. For this reason, all of our slabs are, in some aspects, unique.

All Bellitalia® slabs are supplied with anti-degradation paint or anti-slip treatment, except those supplied for installation in public spaces which receive a mandatory anti-slip treatment, and for this reason anti-degradation paint is not applicable.

Queste lastre sono caratterizzate da un aspetto materico e presentano effetti nuvolati di colore non uniforme con leggere cavillature. Questo perché i diversi componenti che vanno a formare la miscela del calcestruzzo sono estremamente sensibili ai cambiamenti ambientali durante il periodo di maturazione. Per questo motivo tutte le nostre lastre sono, per certi aspetti, uniche nel loro genere. Tutte le lastre di Bellitalia® sono fornite con vernice antidegrado o trattamento antiscivolo, tranne quelle fornite per l'installazione nei luoghi pubblici che ricevono un trattamento obbligatorio antiscivolo e per tale motivo non è applicabile la vernice antidegrado.

Estas losas se caracterizan por un aspecto matérico y presentan efectos matizados de color no uniforme con ligeras grietas. Esto se debe a que los varios componentes que forman la mezcla del cemento son sumamente sensibles a los cambios ambientales durante el periodo de curado. Por este motivo todas nuestras losas son, en algunos aspectos, únicas en su género. Todas las losas de Bellitalia® se suministran con pintura antideterioro o con tratamiento antideslizamiento, salvo las suministradas para instalaciones en lugares públicos, que reciben, obligatoriamente, un tratamiento antideslizamiento y, por dicho motivo, no se les aplica la pintura antideterioro.

Ces plaques, d'aspect matérique, présentent des effets nuageux de couleur non homogène avec de légères fissures. Cela parce que les différents composants du béton sont extrêmement sensibles aux changements environnementaux lors de la période de maturation. C'est pour cette raison que toutes nos plaques sont, d'une certaine façon, uniques en leur genre. Toutes les plaques de Bellitalia® sont fournies avec un vernis anti-graffiti ou avec un traitement antidérapant, sauf celles étant destinées aux lieux publics, qui subissent en revanche un traitement obligatoire antidérapant et c'est pour cela qu'aucune couche de vernis anti-graffiti n'est appliquée.

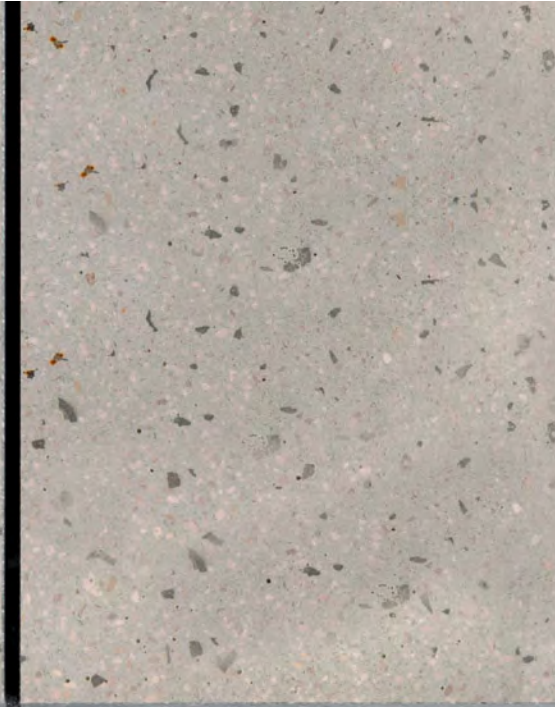
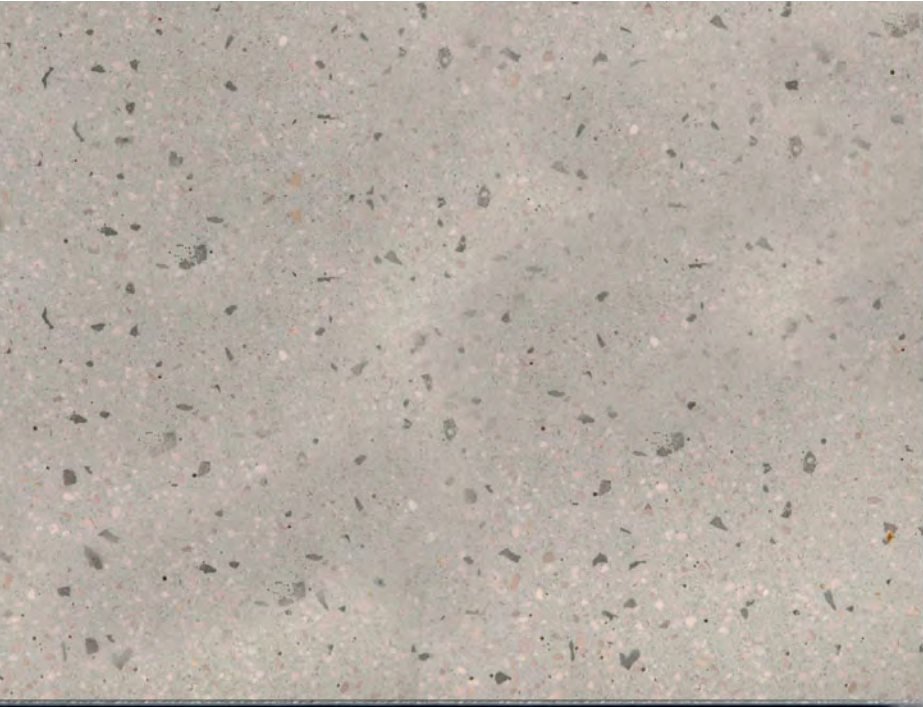

TECHNICAL FEATURES



Standard dimensions available for slabs with a 35 mm width, usually purchased for installation on adjustable feet, and with a 20 mm width, only for installation on bed of sand

Starting slab dimensions:

1000x1000 mm | 500x1000 mm | 500x500 mm

Custom sizes are available on request.

For texture and available color, please refer to Bellitalia®'s samples folder.

Dimensioni standard disponibili con spessore 35 mm, normalmente utilizzato per pose su piedini regolabili, oppure 20 mm, per posa su letto di sabbia e cemento:

1000x1000 mm | 500x1000 mm | 500x500 mm

Su richiesta sono quotabili tagli a misura.

Per colori e texture, fare riferimento alla cartellina campioni Bellitalia®.

Dimensiones estándares disponibles con espesor de 35 mm, normalmente utilizado para la colocación sobre pies regulables, o de 20 mm, para la colocación sobre lecho de arena y cemento:

1000x1000 mm | 500x1000 mm | 500x500 mm

Bajo pedido, se puede presupuestar cortes a medida.

Para los colores y acabados, le rogamos que haga referencia a las muestras que se encuentran en la carpeta muestrario de Bellitalia®.

Dimensions standard disponibles avec largeur 35 mm, normalement utilisé pour les poses sur pieds réglables, ou 20 mm, pour la pose sur lit de sable et de béton:

1000x1000 mm | 500x1000 mm | 500x500 mm

Des coupes sur mesure peuvent être cotées sur demande.

Pour les couleurs et les textures, veuillez vous référer au dossier des échantillons Bellitalia®.



GRANITO BIANCO

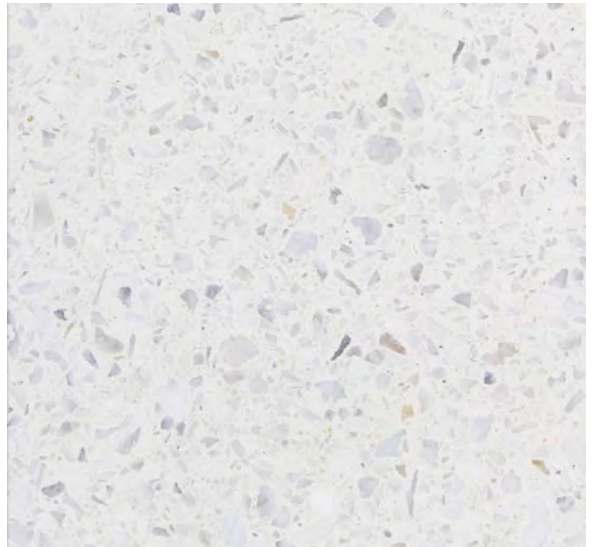

BIANCO CARRARA

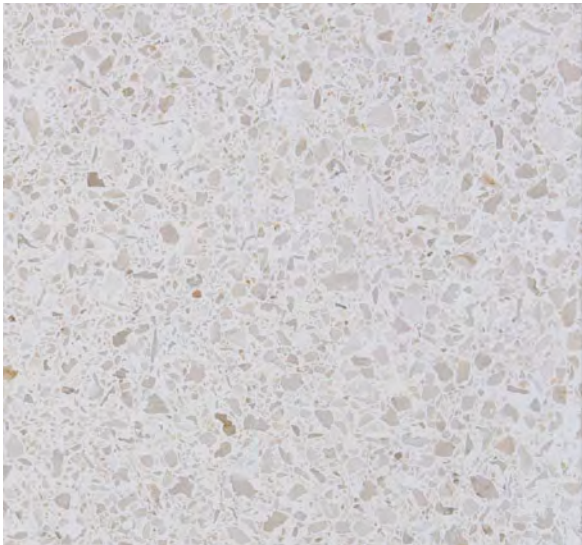

BOTTICINO



VENEZIANO

CONCRETE SLABS

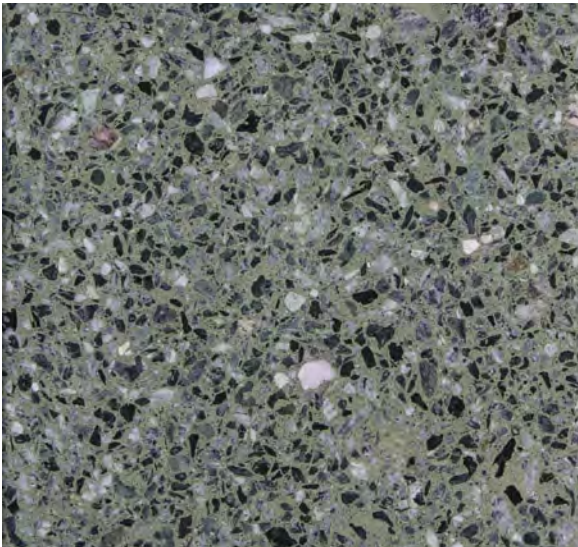

VERDE ALPI



ROSSO VERONA

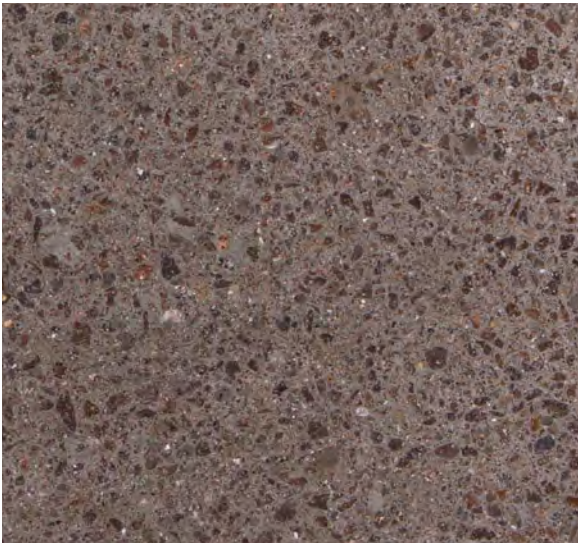

PORFIDO



NERO EBANO

For texture and available colors, please refer to Bellitalia®'s samples folder.
Per colori e texture, fare riferimento alla cartella campioni Bellitalia®.

Para los colores y acabados, le rogamos que haga referencia a las muestras que se encuentran en la carpeta muestrario de Bellitalia®.
Pour les couleurs et les textures, veuillez vous référer au dossier des échantillons Bellitalia®.

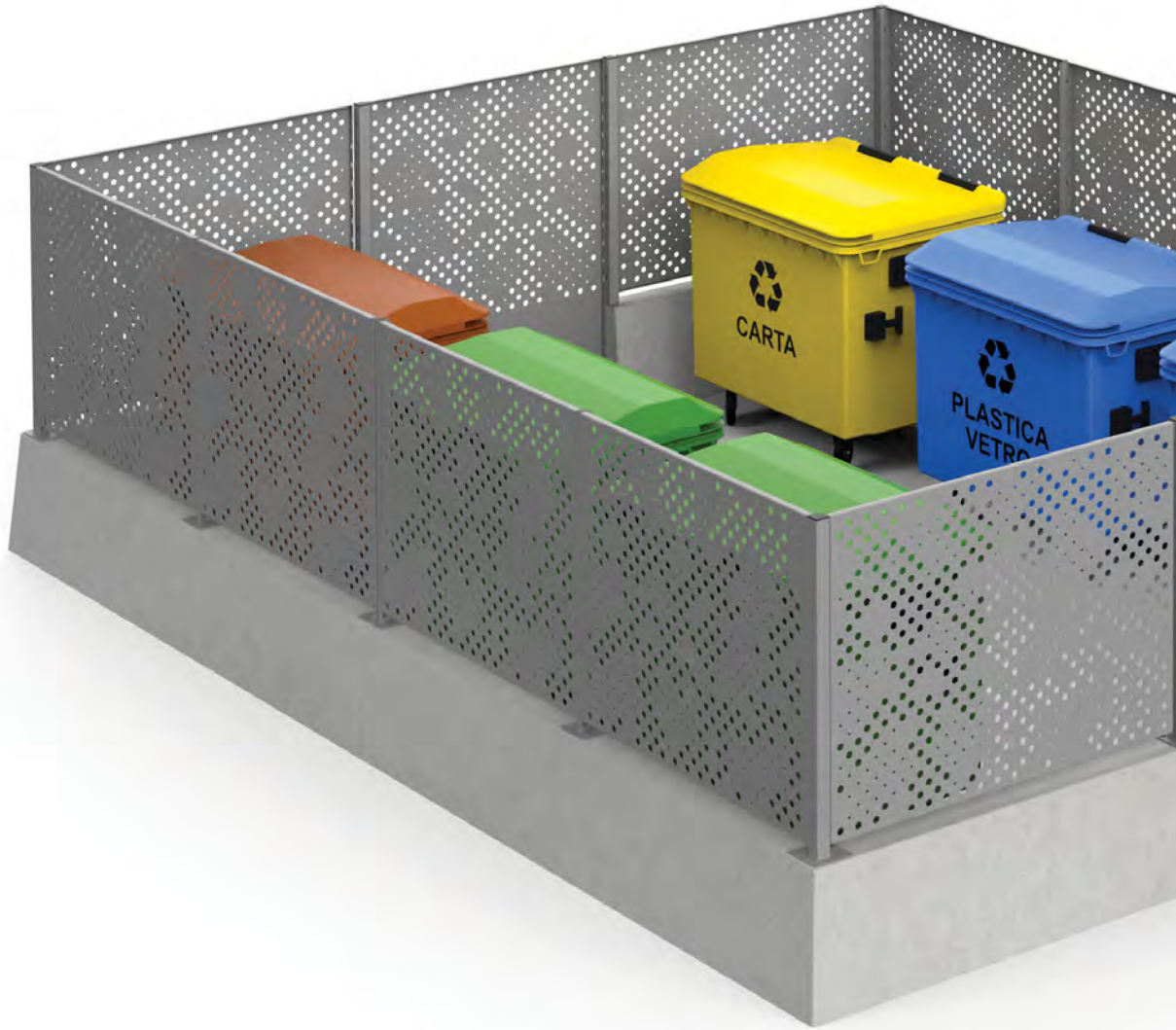

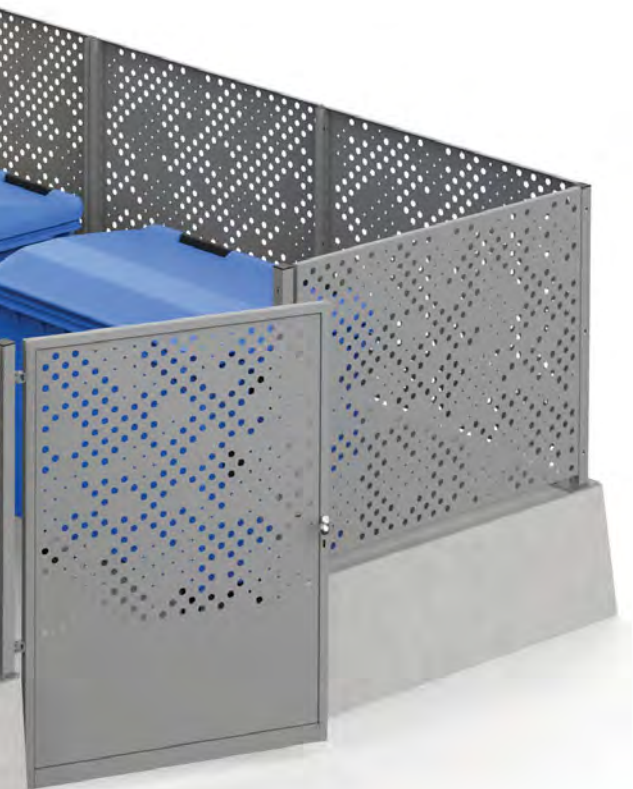

RETROSCENA



RETROSCENA

BELLITALIA DESIGN

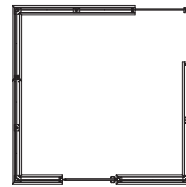
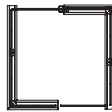
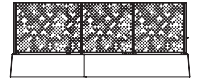
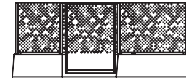
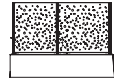
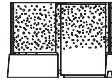

MINI

L 2955 mm
W 2824 mm
H 1972 mm
2624 kg

MEDIUM

L 4750 mm
W 4750 mm
H 1972 mm
4552 kg

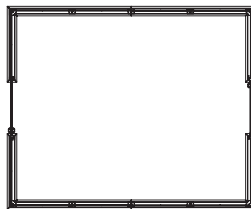
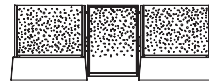
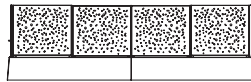

MAXI

L 6502 mm
W 5348 mm
H 1972 mm
6390 kg

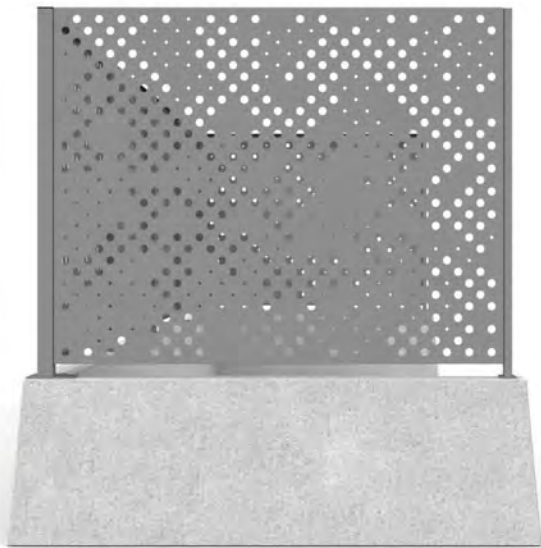
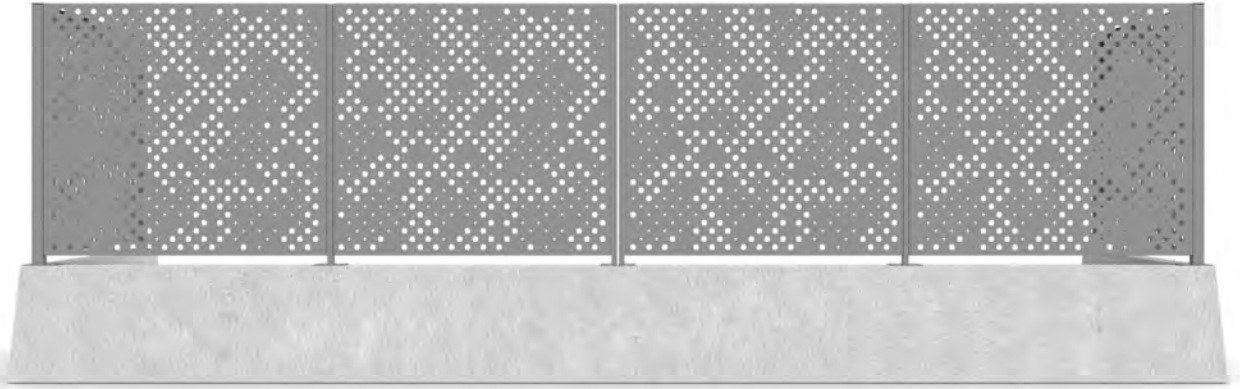

RETROSCENA

BELLITALIA DESIGN



OPEN

L 6502 mm
W 2000 mm
H 1972 mm
3233 kg

MATERIALS / MATERIALI / MATERIALES / MATÉRIAUX:

PIETRE PREZIOSE



GRANITO



POWDER COATED STEEL
ACCIAIO VERNICIATO
ACERO PINTADO
ACIER THERMOLAQUÉ



FINISHING / FINITURE / ACABADOS / FINITIONS:



RAL

ACCESSORIES / ACCESSORI / ACCESORIOS / ACCESSOIRES:





MAGNUM EVOLUTION S

BELLITALIA DESIGN

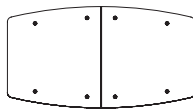
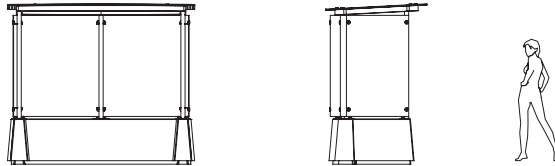

L 2687 mm
W 1469 mm
H 2300 mm
1611 kg

MATERIALS / MATERIALI / MATERIALES / MATÉRIAUX:

PIETRE PREZIOSE



GRANITO



POWDER COATED STEEL
ACCIAIO VERNICIATO
ACERO PINTADO
ACIER THERMOLAQUÉ



FINISHING / FINITURE / ACABADOS / FINITIONS:

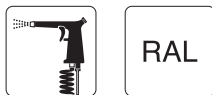

ACCESSORIES / ACCESSORI / ACCESORIOS / ACCESSOIRES:





MAGNUM EVOLUTION S

BELLITALIA DESIGN





MAGNUM EVOLUTION L

BELLITALIA DESIGN

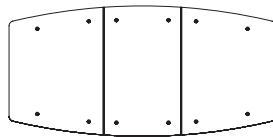
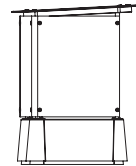
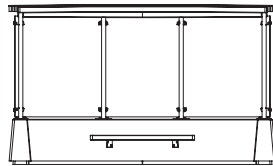

L 3839 mm
W 1897 mm
H 2300
2238 kg

MATERIALS / MATERIALI / MATERIALES / MATÉRIAUX:

PIETRE PREZIOSE



GRANITO



POWDER COATED STEEL
ACCIAIO VERNICIATO
ACERO PINTADO
ACIER THERMOLAQUÉ



FINISHING / FINITURE / ACABADOS / FINITIONS:



ACCESSORIES / ACCESSORI / ACCESORIOS / ACCESSOIRES:





MAGNUM EVOLUTION L

BELLITALIA DESIGN





The image shows two concrete test specimens on a light-colored wooden surface. On the left is a rectangular specimen with a textured, porous appearance. On the right is an L-shaped specimen, also with a textured surface. The background is blurred, showing what appears to be a laboratory or workshop setting with various equipment and materials.

MATERIALS AND TECHNICAL DETAILS
MATERIALI E DETTAGLI TECNICI
MATERIALES Y DETALLES TÉCNICOS
MATÉRIAUX ET DÉTAILS TECHNIQUES

ATOMS



A servizio di Bellitalia, è nato il nostro laboratorio ATOMS, "Material Design Research For A Sustainable Future", che ha l'obiettivo di condurre costantemente ricerche e test sulle nostre miscele cementizie e sulle relative tecniche produttive, al fine di sviluppare soluzioni sempre più performanti e sostenibili.

At the service of Bellitalia, our laboratory ATOMS, "Material Design Research For A Sustainable Future" was born with the aim of constantly conducting research and tests on our concrete mixtures and on our production techniques, to develop more performing and sustainable solutions.

MATERIAL DESIGN RESEARCH FOR A SUSTAINABLE FUTURE

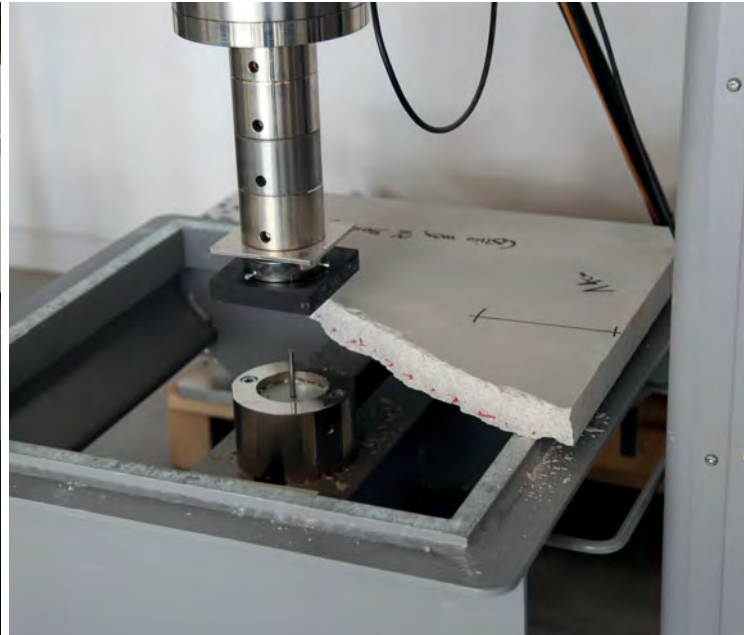

Al servicio de Bellitalia nació nuestro laboratorio ATOMS, “Material Design Research For A Sustainable Future”, con el objetivo de realizar constantemente investigaciones y pruebas sobre nuestras mezclas de cemento y sus técnicas de producción, para desarrollar soluciones cada vez más eficientes y sostenibles.

Au service de Bellitalia est né notre laboratoire ATOMS, “Material Design Research For A Sustainable Future”, dans le but de mener constamment des recherches et des tests sur nos mélanges de béton et leurs techniques de production, afin de développer des solutions toujours plus efficaces et durables.

PRECIOUS STONE - RECONSTITUTED PRESTIGIOUS STONE

PIETRE PREZIOSE - PIETRE DI GRANITO RICOSTITUIE

PIEDRAS RECONSTITUIDAS - PIEDRAS PRECIOSAS RECONSTITUIDAS

PIERRE RECONSTITUÉE - PIERRES PRÉCIEUSES RECONSTITUÉES

RECONSTITUTED STONE

Bellitalia® has created its own formulas to recreate the beauty of natural stone combined with the technical characteristics of concrete. Bellitalia® reconstituted stones are divided into Reconstituted Precious Stones and Reconstituted Granite.

RECONSTITUTED PRESTIGIOUS STONE

Bellitalia® manufactures its own reconstituted prestigious stones using a base of Portland cement and aggregates of highly prized stone (marble and porphyry) of various sizes sourced from local quarries. We offer a selection of 8 colour variants based on the aggregates used:

PIETRE RICOSTITUIE

Bellitalia® ha ideato le proprie formule per ricreare la bellezza della pietra naturale unita alle caratteristiche tecniche del cemento. Le pietre ricostituite Bellitalia® si dividono in Pietre Preziose Ricostituite e Granito Ricostituito.

PIETRE PREZIOSE RICOSTITUIE

Bellitalia® crea le proprie pietre preziose ricostituite utilizzando una base di cemento Portland e inerti di pietre di pregio (marmi e porfido) di varie pezzature provenienti da cave locali. A seconda degli inerti utilizzati, vi sono 8 varianti colore a scelta tra:

PIEDRAS RECONSTITUIDAS

Bellitalia® ha concebido sus fórmulas para recrear la belleza de la piedra natural combinada con las características técnicas del cemento. Las piedras reconstituidas de Bellitalia® se dividen en Piedras Preciosas Reconstituidas y Granito Reconstituido.

PIEDRAS PRECIOSAS RECONSTITUIDAS

Bellitalia® crea sus piedras preciosas reconstituidas utilizando una base de cemento Portland y áridos de piedras de valor (mármoles y pórfido) de varios tamaños con procedencia de canteras locales. Dependiendo de los áridos utilizados, existen 8 variantes de color a elección entre:

PIERRE RECONSTITUÉE

Bellitalia® a conçu ses formules en vue de recréer la beauté de la pierre naturelle conjuguée aux caractéristiques techniques du ciment. Les pierres reconstituées de Bellitalia® sont classées en pierres précieuses reconstituées et en granit reconstitué.

PIERRES PRÉCIEUSES RECONSTITUÉES

Bellitalia® crée ses pierres précieuses reconstituées à l'aide d'une base de ciment Portland et d'agrégats de pierres de qualité supérieure (marbre et porphyre) de différentes tailles provenant de carrières locales. En fonction des agrégats utilisés, 8 variétés de couleurs sont disponibles:

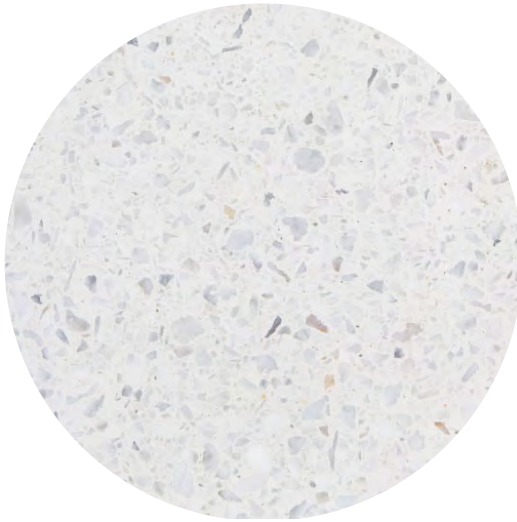

BIANCO CARRARA

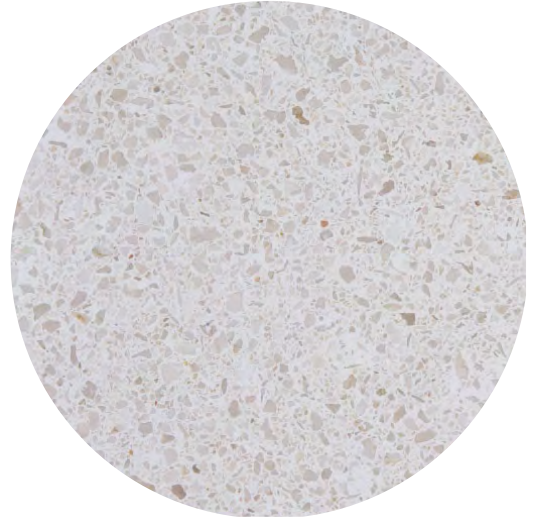

BOTTICINO



ROSSO VERONA

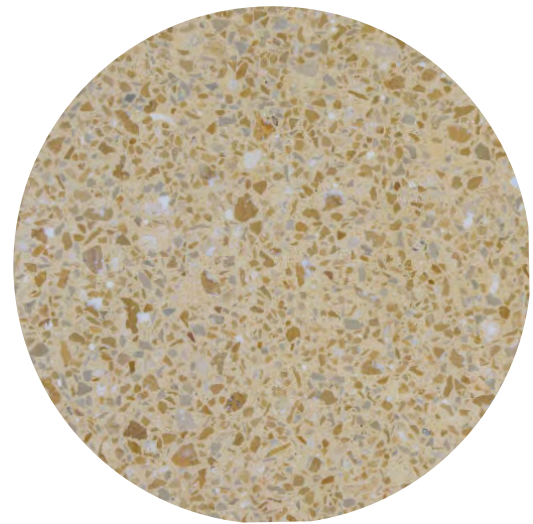

GIALLO MORI

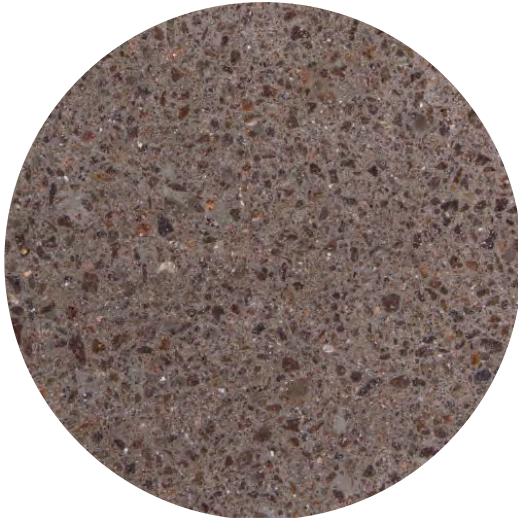

PORFIDO

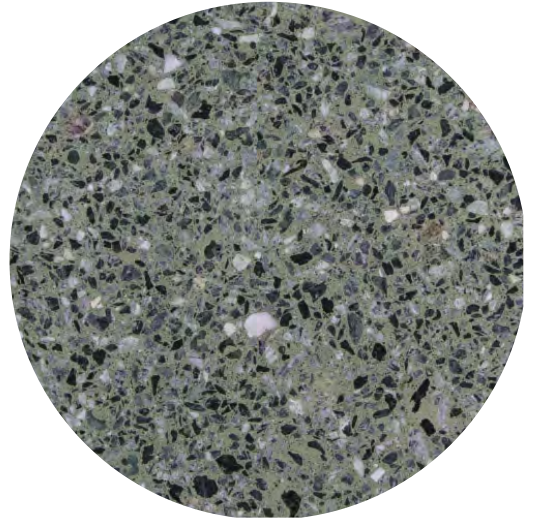

VERDE ALPI

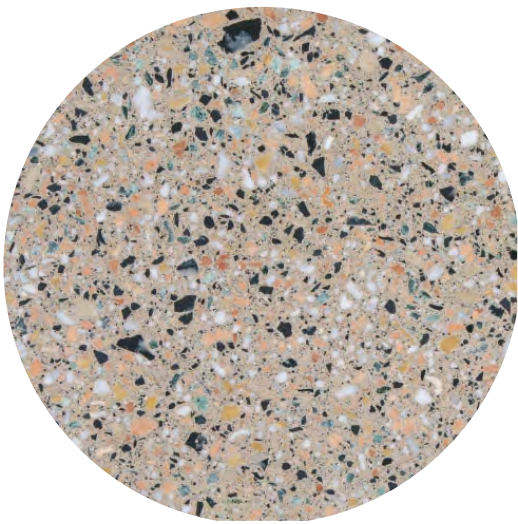

VENEZIANO



NERO EBANO

RECONSTITUTED STONE - RECONSTITUTED GRANITE

PIETRE RICOSTITUITE - GRANITO RICOSTITUITO

PIEDRAS RECONSTITUIDAS - GRANITO RECONSTITUIDO

PIERRES RECONSTITUÉES - GRANIT RECONSTITUÉ

Bellitalia® creates its own reconstituted granite using a Portland cement base and river-based aggregates of various sizes sourced from local quarries. Choose from two colour variants:

Bellitalia® crea il proprio granito ricostituito utilizzando una base di cemento Portland e inerti fluviali di varie pezzature provenienti da cave locali. Vi sono due varianti colore a scelta tra:

Bellitalia® crea su granito reconstituido utilizando una base de cemento Portland y áridos fluviales de varios tamaños con procedencia de canteras locales. Existen dos variantes de color a elección entre:

Bellitalia® crée son granit reconstitué à l'aide d'une base de ciment Portland et d'agrégats de rivière de différentes tailles provenant de carrières locales. Deux variétés de couleurs sont disponibles:



GRANITO GRIGIO



GRANITO BIANCO

FINISHINGS AND TREATMENTS OF PRECIOUS STONES AND GRANITO STONES

FINITURE E TRATTAMENTI PIETRE PREZIOSE & GRANITO

ACABADOS Y TRATAMIENTOS DE PIEDRAS PRECIOSAS Y GRANITO

FINITIONS ET TRAITEMENTS DES PIERRES PRÉCIEUSES ET DU GRANIT

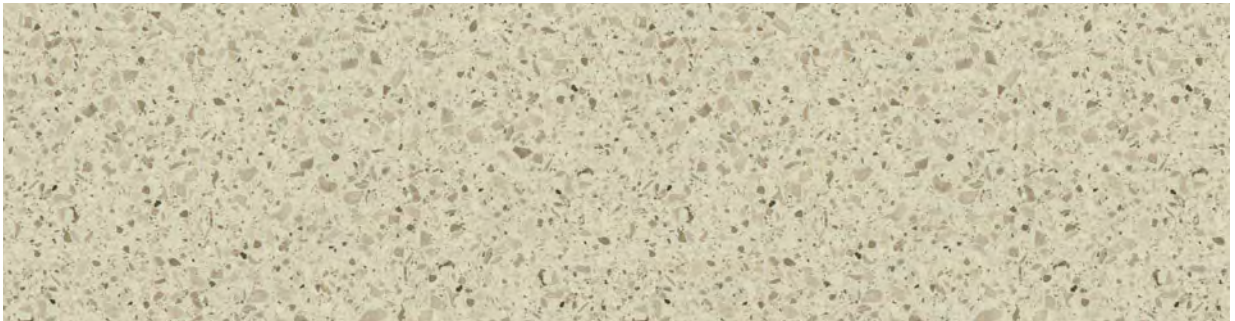

Bellitalia® offers the following finishes on its products made of reconstituted stones (precious and granite).

To verify the available finishes on each product please refer to the relative page of the catalogue.

Bellitalia® opera le seguenti finiture per i propri manufatti in pietre ricostituite (preziose e granito).

Per conoscere le finiture possibili su ciascun prodotto vedere la relativa pagina del catalogo.

Bellitalia® realiza los siguientes acabados para sus productos en piedras reconstituidas (preciosas y granito).

Consultar la página relativa del catálogo para saber cuál/cuáles es/son el/los acabado/s posibles para cada producto.

Bellitalia® réalise les finitions suivantes sur ses produits en pierre reconstituée (pierre précieuse et granit).

Voir la page de catalogue correspondante pour en savoir plus sur les finitions possibles sur chaque produit.

Brushing: the product is polished manually or mechanically with robotic machines that remove the surface layer of the material to give the product a regular surface without porosity.

Spazzolatura: il manufatto viene levigato manualmente o meccanicamente con macchinari robotizzati che rimuovono lo strato superficiale del materiale per conferire al prodotto una superficie irregolare ma senza porosità.

Cepillado: el producto es cepillado manual o mecánicamente con maquinarias robotizadas, que eliminan la capa superficial del material para otorgar al producto una superficie irregular, pero sin porosidades.

Brossage: le produit est poncé manuellement ou mécaniquement à l'aide de machines robotisées qui retirent la couche de surface du matériau afin de conférer à l'article une surface irrégulière, mais non poreuse.

Polishing: the product is polished manually or mechanically with robotic machines that remove the surface layer of the material to give the product a smooth surface.

Levigatura: il manufatto viene levigato manualmente o meccanicamente con macchinari robotizzati che rimuovono lo strato superficiale del materiale per conferire al prodotto una superficie liscia.

Pulido: el producto es pulido manual o mecánicamente con maquinarias robotizadas, que eliminan la capa superficial del material para otorgar al producto una superficie lisa.

Polissage: le produit est poncé manuellement ou mécaniquement à l'aide de machines robotisées qui retirent la couche de surface du matériau afin de conférer à l'article une surface lisse.

Bush hammering: the bush-hammers break the superficial stones, giving the surface a rough appearance that highlights its valuable aggregates.

Bocciardatura: la finitura martellinata rompe superficialmente le pietre, donando al manufatto un aspetto ruvido che fa risaltare al massimo gli inerti pregiati che lo compongono.

Escodado: el acabado escodado rompe las piedras en superficie, otorgando al producto un aspecto rugoso que resalta al máximo los áridos valiosos que lo componen.

Bouchardage: la finition martelée brise les pierres sur la surface, conférant au produit un aspect rugueux valorisant au maximum les fins agrégats qui le composent.

Sandblasting: sandblasting is a mechanical process that uses a powerful jet of compressed air and siliceous sands to perform a surface-layer removal that makes the background stones stand out.

Sabbatura: la sabbatura è una lavorazione meccanica che utilizza un potente getto di aria compressa e sabbie silicee per eseguire un'asportazione superficiale di materiale che fa risaltare le pietre di sottofondo.

Esmerilado con arena: el esmerilado con arena es un tratamiento mecánico, que utiliza un chorro potente de aire comprimido y arenas silíceas, para efectuar una retirada superficial de material, que resalta las piedras de fondo.

Sablage: le sablage est un procédé mécanique employant un puissant jet d'air comprimé et du sable siliceux permettant un décapage superficiel du matériau en faisant ressortir les pierres sous-jacentes.

ULTRATENSE CONCRETE

UTC® by Bellitalia® is a latest-generation UHPC (ultra-high performance concrete).

Comprising a patented blend of very fine aggregates, stainless steel fibres (and in specific cases also glass fibres) and a complex balance of additives expertly mixed to form a homogeneous and compact matrix, UTC® delivers enhanced mechanical properties and excellent fluidity that does not require vibration. This allows us to obtain a good surface appearance for the product straight out of the mould, meaning the manufacturing process for producing this concrete is even more sustainable. For this reason, UTC® is only available with a smooth formwork finish.

Available in a range of 7 colours, which are characterised by the oxides contained in the mixture itself.

UTC® products are treated as standard with a transparent anti-degradation varnish. On request, this treatment can be substituted with an anti-graffiti paint.

UTC® di Bellitalia® è un calcestruzzo della tipologia degli UHPC (ultra high-performance concrete) di ultima generazione. Composto da una miscela brevettata di aggregati finissimi, fibre di acciaio inossidabile (e in casi specifici anche fibre di vetro) e da un complesso bilanciamento di additivi sapientemente mixati per formare una matrice omogenea e compatta, UTC® presenta proprietà meccaniche elevate ed un'ottima fluidità che non richiede vibrazione, permettendo di ottenere un buon aspetto superficiale del manufatto già in fase di apertura dello stampo e rendendo così il processo produttivo di questo calcestruzzo ancora più sostenibile. Per tale ragione UTC® è disponibile solo in finitura liscio cassero.

Le colorazioni disponibili sono 7 e sono caratterizzate dagli ossidi contenuti nell'impasto.

I manufatti in UTC® vengono di norma trattati con una vernice antidegrado trasparente. Su richiesta è possibile sostituire tale trattamento con una vernice anti-graffiti.

UTC® de Bellitalia® es un hormigón del tipo de los UHPC (ultra high-performance concrete) de última generación.

Compuesto por una mezcla con patente de materiales inertes muy finos, fibras de acero inoxidable (y, en casos específicos, también fibras de vidrio) y por un equilibrio complejo de aditivos sabiamente mezclados para formar una matriz homogénea y compacta, UTC® presenta propiedades mecánicas elevadas y una óptima fluidez, que no requiere vibración, permitiendo obtener un buen aspecto superficial del producto durante la fase de apertura del molde y logrando que el proceso de producción de este hormigón sea todavía más sostenible. Por dicho motivo, UTC® está disponible solamente con el acabado liso encofrado.

Los colores disponibles son 7 y se caracterizan por los óxidos contenidos en la masa.

Los productos en UTC® suelen tratarse con una pintura antideterioro transparente. Bajo pedido, dicho tratamiento puede sustituirse por una pintura anti-graffiti.

Le UTC® de Bellitalia® est un béton de dernière génération à ultra haute performance (UHPC).

Composé d'un mélange breveté de granulats très fins, de fibres d'acier inoxydable (et dans certains cas aussi de fibres de verre) et d'un dosage complexe d'additifs minutieusement mélangés de manière à former une matrice homogène et compacte, le UTC® offre des propriétés mécaniques élevées et une excellente fluidité ne nécessitant pas de vibration, ce qui permet d'obtenir un bel aspect de la surface du produit dès l'ouverture du moule rendant ainsi le procédé de fabrication de ce béton encore plus durable. Pour cette raison, le UTC® n'est disponible qu'avec une finition coffrage lisse.

Disponible en 7 couleurs, caractérisées par la présence d'oxydes dans le mélange.

Les produits en UTC® sont généralement traités à l'aide d'un vernis anti-dégradation transparent. Sur demande, il est possible de remplacer ce traitement par un vernis anti-graffiti.



UTC 1



UTC 2

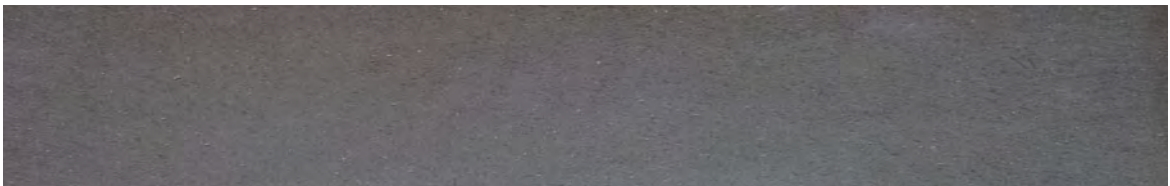

UTC 3

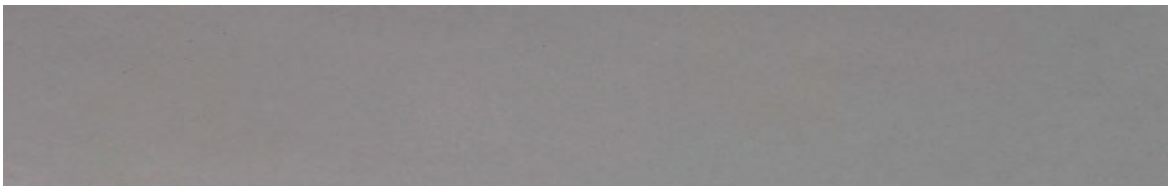

UTC 4



UTC 5

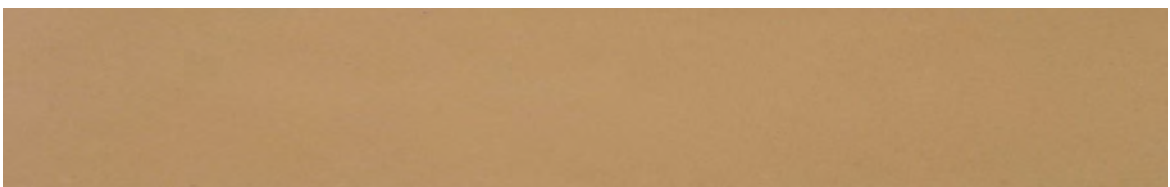

UTC 6

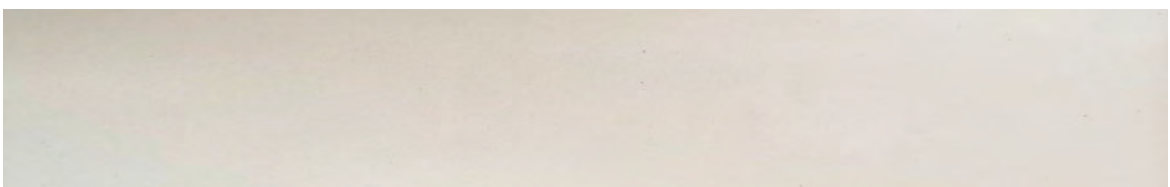

UTC 7

HTC

Bellitalia®'s HTC is a latest-generation HPC (high performance concrete).

Comprising a blend of natural aggregates of differing size and special additives (including in specific cases also glass fibres), HTC delivers good mechanical properties and excellent fluidity that does not require vibration. This allows us to obtain a good surface appearance for the product straight out of the mould, meaning the manufacturing process for producing this concrete is even more sustainable. For this reason, HTC is only available in a smooth formwork finish.

Available in a range of 7 colours, which are characterised by the oxides contained in the mixture itself.

HTC products are usually treated with a transparent anti-degradation varnish. On request, this treatment can be substituted with an anti-graffiti paint.

HTC di Bellitalia® è un calcestruzzo della tipologia degli HPC (high performance concrete) di ultima generazione.

Composto da una miscela di aggregati naturali di varie pezzature e speciali additivi (e in casi specifici anche da fibre di vetro), HTC presenta buone proprietà meccaniche ed un'ottima fluidità che non richiede vibrazione, permettendo di ottenere un buon aspetto superficiale del manufatto già in fase di apertura dello stampo, rendendo così il processo produttivo di questo calcestruzzo ancora più sostenibile. Per tale ragione l'HTC è disponibile solo in finitura liscio cassero.

Le colorazioni disponibili sono 7 e sono caratterizzate dagli ossidi contenuti nell'impasto.

I manufatti in HTC vengono di norma trattati con una vernice antidegrado trasparente. Su richiesta è possibile sostituire tale trattamento con una vernice anti-graffiti.

HTC de Bellitalia® es un hormigón del tipo de los HPC (high performance concrete) de última generación.

Compuesto por una mezcla de materiales inertes naturales de varios tamaños y aditivos especiales (y, en casos específicos, también fibras de vidrio), HTC presenta buenas propiedades mecánicas y una óptima fluidez, que no requiere vibración, permitiendo obtener un buen aspecto superficial del producto durante la fase de apertura del molde y logrando que el proceso de producción de este hormigón sea todavía más sostenible. Por dicho motivo, HTC está disponible solamente con el acabado liso encofrado.

Los colores disponibles son 7 y se caracterizan por los óxidos contenidos en la masa.

Los productos en HTC suelen tratarse con una pintura antideterioro transparente. Bajo pedido, dicho tratamiento puede sustituirse por una pintura anti-graffiti.

Le HTC de Bellitalia® est un béton de dernière génération à haute performance (HPC).

Composé d'un mélange de granulats naturels de différentes tailles et d'additifs spéciaux (et dans certains cas aussi de fibres de verre), le HTC offre un bon pouvoir mécanique et une excellente fluidité ne nécessitant pas de vibration, ce qui permet d'obtenir un bel aspect de la surface du produit dès l'ouverture du moule rendant ainsi le procédé de fabrication de ce béton encore plus durable. Pour cette raison, le HTC n'est disponible qu'avec une finition coffrage lisse.

Disponible en 7 couleurs, caractérisées par la présence d'oxydes dans le mélange.

Les produits en HTC sont généralement traités à l'aide d'un vernis anti-dégradation transparent. Sur demande, il est possible de remplacer ce traitement par un vernis anti-graffiti.



HTC 1



HTC 2

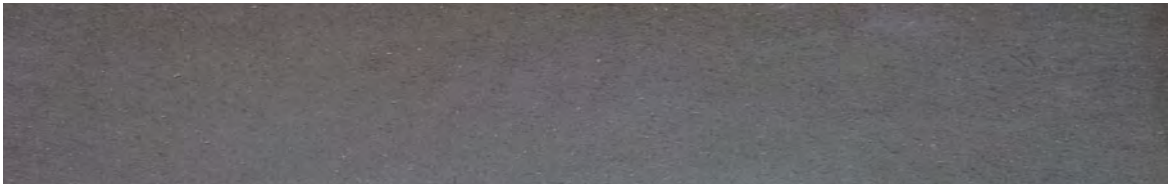

HTC 3

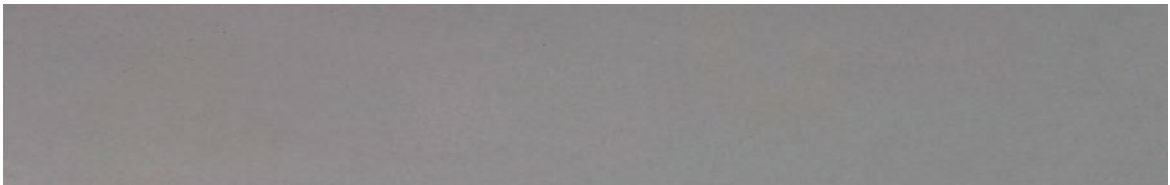

HTC 4

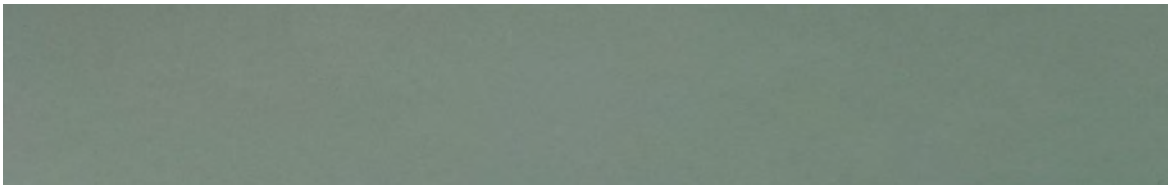

HTC 5

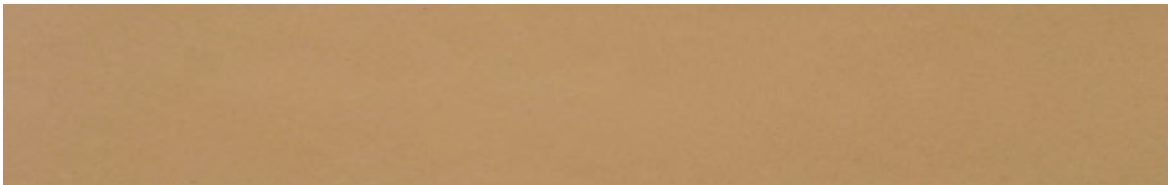

HTC 6

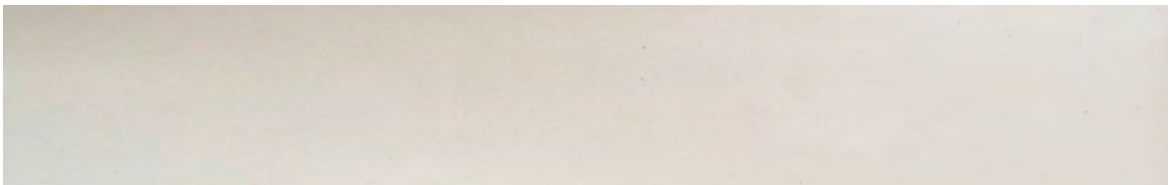

HTC 7

NATURAL FEATURES OF CONCRETE

CARATTERISTICHE NATURALI DEL CALCESTRUZZO

CARACTERÍSTICAS NATURALES DEL HORMIGÓN

CARACTÉRISTIQUES NATURELLES DU BÉTON

In general, superficial aspect of concrete cannot be perfectly uniform and smooth due its production process/ characteristics. Particularly, the following features are to be considered normal:

CLOUDY EFFECTS

These are colour variations. They are typical of concrete and they are influenced by the interaction with humidity and external environmental agents. They can occur and vary at any point of the life of the product.

They are more visible when the surface of the product is left natural/unprocessed (e.g., HTC and UTC).

AIR BUBBLES

They are caused by air bubbles trying to flow out of the concrete mix but remaining trapped when reaching the surface.

HAIRLINE CRACKS

They are small fissures (non-structural), caused by the contraction of the material due to the evaporation of the humidity content. They can occur at any point of the life of the product, and they become more visible when concrete is wet.

In generale, l'aspetto superficiale del calcestruzzo non è perfettamente uniforme e liscio a causa del suo processo di produzione e delle naturali caratteristiche tecniche del materiale stesso. In particolare, le seguenti caratteristiche sono da considerarsi normali:

NUVOLATURE

Si tratta di variazioni di colore. Sono tipiche del calcestruzzo e sono influenzate dall'interazione con l'umidità e gli agenti ambientali esterni. Possono verificarsi e variare in qualsiasi momento della vita del prodotto.

Sono più visibili quando la superficie del prodotto viene lasciata liscio cassero/non trattata (ad esempio, HTC e UTC).

VAIOLATURE

Essi sono causati da bolle d'aria che cercano di fluire fuori dalla miscela di cemento, ma rimanendo intrappolati quando raggiunge la superficie.

FESSURAZIONI

Sono piccole fessure (non strutturali), causate dalla contrazione del materiale dovuta all'evaporazione del umidità contenuta nella miscela cementizia. Possono verificarsi in qualsiasi punto della vita del prodotto e diventano più visibili quando il calcestruzzo è bagnato.

En general, el aspecto superficial del hormigón no puede ser perfectamente uniforme ni liso por sus características y su proceso de producción. En particular, las siguientes características se han de considerar normales:

EFFECTOS NUBOSOS

Son variaciones de color. Son típicos del hormigón y les afecta la interacción con la humedad y los agentes ambientales externos. Pueden producirse y cambiar en cualquier momento de la vida del producto.

Son más visibles cuando la superficie del producto se deja natural/sin tratamientos (por ej.: HTC y UTC).

BURBUJAS DE AIRE

Son causadas por burbujas de aire que intentan salirse de la mezcla de hormigón, pero que permanecen atrapadas al llegar a la superficie.

GRIETAS FINAS

Son pequeñas hendiduras (no estructurales), causadas por la contracción del material debido a la evaporación de la humedad contenida. Pueden producirse en cualquier momento de la vida del producto y resultan más visibles cuando el hormigón está húmedo.

En général, l'aspect superficiel du béton ne saurait être parfaitement uniforme et lisse en raison de son procédé de fabrication et de ses caractéristiques. En particulier, les caractéristiques suivantes sont à considérer comme normales :

EFFETS NUAGEUX

Il s'agit de variations de couleur. Typiques du béton, ces effets résultent de l'interaction avec l'humidité et les agents environnementaux extérieurs. Ils sont susceptibles de se produire et de varier à tout moment de la durée de vie du produit.

Ils sont plus apparents lorsque la surface du produit reste naturelle et non traitée (par exemple, HTC et UTC).

BULLES D'AIR

Elles résultent de bulles d'air qui tentent de sortir du mélange de béton, mais restent emprisonnées une fois à la surface.

FISSURES

Ce sont de petites fissures (non structurales), provoquées par la contraction du matériau à cause de l'évaporation de l'humidité contenue. Elles peuvent apparaître à tout moment de la durée de vie du produit, et deviennent plus apparentes lorsque le béton est humide.



VARNISH COATING ON CONCRETE - GLOSSY/MATTE

VERNICIATURA SU CEMENTO - GLOSSY/MATTE

PINTURA EN CEMENTO - GLOSSY/MATTE

PEINTURE SUR CIMENT - GLOSSY/MATTE

Bellitalia® offers the possibility of painting some concrete products with RAL colours in glossy or matte finish (for the available standard RAL, see Bellitalia® Concrete Color Chart on pg. 445). The coloring process involves the application of a two-component epoxy base and then two coats of colored polyurethane finish.

Bellitalia® propone la possibilità di verniciare alcuni manufatti in cemento con colorazioni RAL in finitura glossy o matte (per i RAL standard disponibili, vedere Bellitalia® Concrete Color Chart a pag. 445) Il processo di colorazione prevede l'applicazione di una base bicomponente epossidica e successivamente due mani di finitura poliuretanic colorata.

Bellitalia® propone la posibilidad de pintar algunos productos con colores RAL en acabado brillante y mate (para los RAL estándares disponibles, consultar Bellitalia® Concrete Color Chart en la pág. 445) El proceso de color contempla la aplicación de una base de dos componentes epoxi y, posteriormente, dos capas de acabado poliuretánico de color.

Bellitalia® offre la possibilité de peindre certains produits en ciment avec des couleurs RAL au fini brillant ou mat (voir le nuancier Bellitalia® Concrete Color Chart à la page 445 pour les couleurs RAL classiques) Le procédé de coloration implique l'application d'une base d'époxy à deux composants, puis de deux couches de finition en polyuréthane coloré.

STEEL
ACCIAIO
ACERO
ACIER

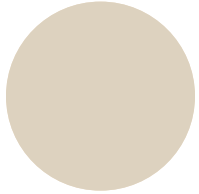

RAL 1013

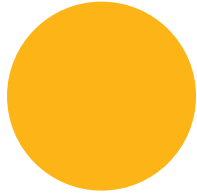

RAL 1021

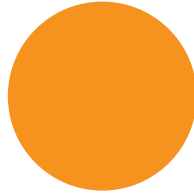

RAL 1028

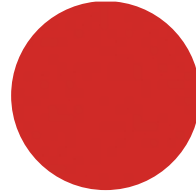

RAL 2002

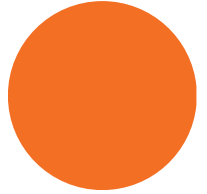

RAL 2004

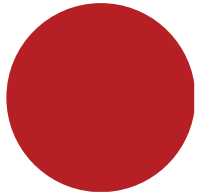

RAL 3000

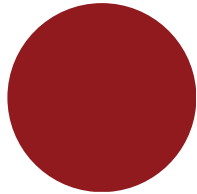

RAL 3003

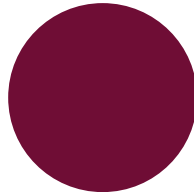

RAL 3005

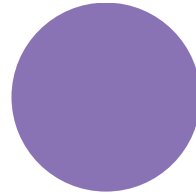

RAL 4005

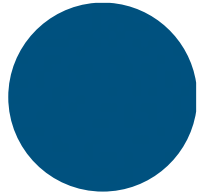

RAL 5010

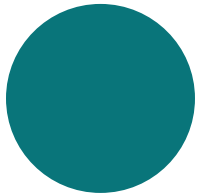

RAL 5021

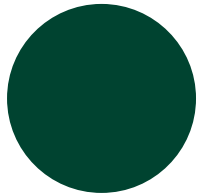

RAL 6005

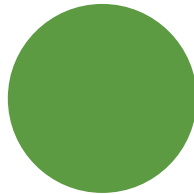

RAL 6018

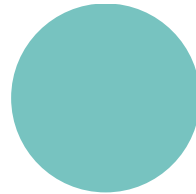

RAL 6027

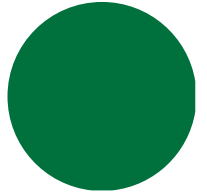

RAL 6029

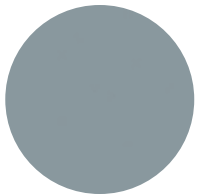

RAL 7001

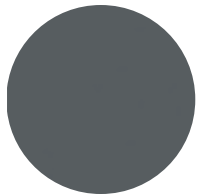

RAL 7012

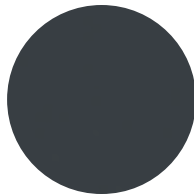

RAL 7016

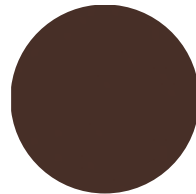

RAL 8017

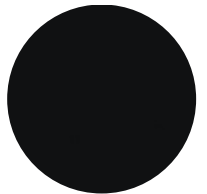

RAL 9005

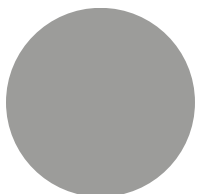

RAL 9006

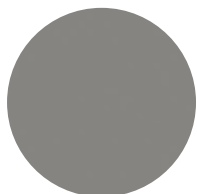

RAL 9007



RAL 9010

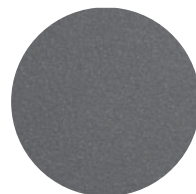

GREY

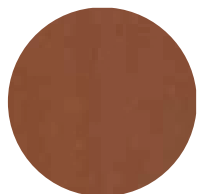

CORTEN COLOR

FINISHING AND TREATMENTS

FINITURE E TRATTAMENTI

ACABADOS Y TRATAMIENTOS

FINITIONS ET TRAITEMENTS

For painted steel or stainless steel components, Bellitalia® uses P.P. paints with a rough matt finish as standard. However for parts which will subsequently have adhesives applied, Bellitalia® uses P.P. paints with a smooth glossy finish. To view the available colours, see Bellitalia® Steel Colour Chart on pg. 445

Before painting on steel, use the most suitable galvanizing treatment based on the thickness and manufacturing process characteristics of the product:

- hot dip galvanizing
- sendzimir galvanizing
- cold electrolytic galvanizing
- cathoresis

Per i propri componenti in acciaio o acciaio inox verniciati, Bellitalia® utilizza di norma vernici P.P. con finitura opaca raggrinzante. In caso di parti predisposte per l'applicazione di adesivi, Bellitalia® utilizza invece vernici P.P. con finitura liscia lucida. Per le colorazioni disponibili, vedere Bellitalia® Steel Color Chart a pag. 445

Prima della verniciatura su acciaio, utilizza il sistema di zincatura più adatto in base alle caratteristiche di spessore e di processo di lavorazione del manufatto:

- zincatura a caldo
- zincatura sendzimir
- zincatura elettrolitica a freddo
- cataforesi

Bellitalia® suele utilizar pinturas P.P. con acabado mate rugoso para sus componentes en acero o acero inoxidable pintados. En cambio, Bellitalia® utiliza pinturas P.P. con acabado liso brillante para partes preparadas para la aplicación de adhesivos. Para los colores disponibles, consultar Bellitalia® Steel Color Chart en la pág. 445

Antes de pintar el acero, utiliza el sistema de galvanización más idóneo en función de las características de grosor y de proceso de tratamiento del producto:

- galvanización en caliente
- procedimiento Sendzimir
- cincado electrolítico en frío
- cataforesis

Bellitalia® utilise généralement des peintures PP à finition opaque structurée pour ses composants peints en acier ou en acier inoxydable. Lorsqu'il s'agit de pièces destinées à l'application d'adhésifs, Bellitalia® utilise plutôt des peintures PP à finition lisse et brillante. Voir le nuancier Bellitalia® Steel Color Chart à la page 445 pour connaître les couleurs disponibles.

Avant de peindre sur l'acier, utiliser le système de galvanisation le mieux adapté en fonction de l'épaisseur et des particularités du processus de transformation du produit:

- galvanisation à chaud
- galvanisation par procédé de Sendzimir
- zingage électrolytique à froid
- cataphorèse

STAINLESS STEEL

ACCIAIO INOX

ACERO INOX

ACIER INOX



For stainless steel components Bellitalia®, as standard, uses stainless steel 304 AISI or L, with satin finish. It is possible to request electropolishing treatment.

In case of installation in particularly harsh environmental conditions, the use of 316 stainless steel is recommended: in this case, check the feasibility of the variation from 304 to 316 with Bellitalia®'s sales offices.

Per i componenti in acciaio inox di norma Bellitalia® utilizza inox 304 AISI o L, con finitura satinata. E' possibile richiedere trattamento di elettrolucidatura.

In caso di posizionamento in condizioni ambientali particolarmente aggressive, si raccomanda l'utilizzo di acciaio Inox 316: in tal caso, verificare la fattibilità della variazione da 304 a 316 con Bellitalia®.

Bellitalia® suele utilizar inox 304 AISI o L, con acabado satinado, para los componentes de acero inoxidable. Se puede pedir un tratamiento de electropulido.

En caso de colocación en condiciones ambientales especialmente agresivas, se recomienda utilizar acero inoxidable 316: en dicho caso, comprobar la viabilidad del cambio de 304 a 316 con Bellitalia®.

Bellitalia® utilise généralement de l'acier inoxydable AISI 304 ou L, avec finition satinée pour les composants en acier inoxydable. Un traitement d'électropolissage est possible sur demande.

Si le produit est posé dans un environnement fortement sollicité, il est recommandé d'utiliser l'acier inoxydable 316: dans ce cas, il convient de vérifier auprès de Bellitalia® si le remplacement du 304 par le 316 est possible.

PORCELAIN STONEWARE

GRES PORCELLANATO

GRES PORCELÁNICO

GRÈS CÉRAME



LIGHT / CHIARO



DARK / SCURO

Bellitalia® selected, for some of its products, the porcelain stoneware with a finish that recalls the wood veining in two different colors (light and dark).

Porcelain stoneware is an ecological and recyclable material, characterized by a good life cycle, thanks to its interesting technical qualities: resistant to thermal changes and frost, it is hygienic because non-porous, and it is salt corrosion-resistant.

Bellitalia® ha selezionato, per alcuni suoi prodotti, gres porcellanato con finitura che richiama le venature del legno in due diverse colorazioni (una chiara e una scura).

Il gres porcellanato è un materiale ecologico e riciclabile, caratterizzato da un buon ciclo di vita, grazie alle sue qualità tecniche interessanti: resistente agli sbalzi termici ed ingelivo, è igienico perchè poco poroso e presenta una buona resistenza alla corrosione salina.

Bellitalia® ha seleccionado para algunos de sus productos el gres porcelánico con un acabado, que recuerda los veteados de la madera en dos colores diferentes (uno claro y otro oscuro).

El gres porcelánico es un material ecológico y reciclable, caracterizado por un ciclo de vida bueno, por sus calidades técnicas interesantes: resistente a los cambios bruscos térmicos y al hielo, es higiénico porque es poco poroso y presenta una resistencia buena a la corrosión salina.

Pour certains de ses produits, Bellitalia® a sélectionné un grès cérame avec une finition évoquant les veines du bois dans deux coloris différents (clair et foncé).

Le grès cérame est un matériau écologique et recyclable caractérisé par une durée de vie appréciable, grâce à ses qualités techniques intéressantes: résistant aux chocs thermiques et au gel, il est hygiénique en raison de sa faible porosité et de sa bonne résistance à la corrosion saline.

WOOD
LEGNO
MADERA
BOIS



OKUMÉ / OKUMÉ / OKUME / OKUMÉ



CONIFER WOOD / CONIFERA /
MADERA DE CONÍFERA / BOIS DE CONIFÈRES



HARDWOOD / LEGNO DURO / MADERA DURA / BOIS DUR

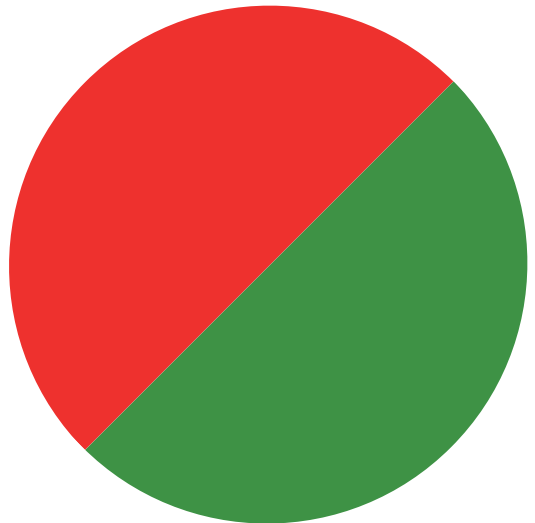

PAINTED OKUMÉ / OKUMÉ VERNICIATO /
OKUME PINTADO / OKUMÉ PEINT

Bellitalia® has selected three categories of woods for its products:

HARDWOOD (Iroko, Movingui or similar)

From time to time, Bellitalia® reserves the right to select the hardwoods most suited to the needs of the product and/or project and/or according to market availability.

Hardwood is supplied with a water-based pigmented finish treatment, but on request the wood can be supplied without a finish treatment. On request, hardwood is also available with FSC certification.

CONIFER WOOD (Pine, Fir or similar)

From time to time, Bellitalia® reserves the right to select the type of coniferous wood that best suits the needs of the product and/or project and/or according to market availability. Depending on the technical characteristics of the product, Bellitalia® uses laminated or solid conifer wood.

Conifer wood is always supplied with a water-based pigmented finish treatment.

On request, conifer wood is also available with FSC certification.

OKUMÉ

Depending on the technical characteristics of the product, Bellitalia® uses multilayer or solid Okumé wood.

Okumé wood is always supplied with a water-based pigmented finishing treatment, and upon request, on specific items, green and red color are available.

To find out the type of wood used for each product, consult the relevant page in our catalogue.

N.B. Wood is a natural material, and as such, its appearance can change naturally over time. This is mainly as a result of:

- a natural tendency to become greyer. This can be more or less marked and/or rapid depending on the type of wood and/or the environmental characteristics of the place in which the product is installed
- a natural tendency to develop cracks and fissures due to volume changes caused by climatic/environmental variations at the place the product is installed

These characteristics are thus to be considered typical and do not constitute a product defect.

However, please remember that adequate and frequent maintenance of wooden products specific to the type of wood chosen and the environmental conditions of the place in which it is installed help to preserve their quality and longevity by slowing down natural ageing of the material.

Bellitalia® ha selezionato tre categorie di legni per i propri prodotti:

LEGNO DURO (Iroko, Movingui o similari)

Bellitalia® si riserva di selezionare di volta in volta i legni duri più adatti alle esigenze di prodotto e/o progetto e/o secondo le disponibilità del mercato.

Il legno duro viene fornito con trattamento di finitura pigmentato a base d'acqua, ma è possibile richiedere che il legnovenga fornito senza trattamento di finitura. Su richiesta, il legno duro, è disponibile anche con certificazione FSC.

LEGNO DI CONIFERA (Pino, Abete o similari)

Bellitalia® si riserva di selezionare di volta in volta la tipologia di legno di conifera più adatta alle esigenze di prodotto e/o progetto e/o secondo le disponibilità del mercato. A seconda delle caratteristiche tecniche del prodotto, Bellitalia® utilizza legno di conifera lamellare o massello.

Il legno di conifera viene sempre fornito con trattamento di finitura pigmentato a base d'acqua.

Su richiesta, il legno di conifera è disponibile anche con certificazione FSC.

OKUMÉ

A seconda delle caratteristiche tecniche del prodotto, Bellitalia® utilizza legno di Okumé multistrato o massello.

Il legno di Okumé viene sempre fornito con trattamento di finitura pigmentato a base d'acqua, e su richiesta, per specifici articoli, colorato verde e rosso.

Per conoscere la tipologia di legno utilizzata per ciascun prodotto vedere la relativa pagina del catalogo.

N.B. Il legno è un materiale naturale e, in quanto tale, è fisiologico che vari aspetti nel tempo soprattutto grazie a:

- una naturale tendenza all'ingrigimento, più o meno marcata e/o rapida a seconda della tipologia di legno e/o delle caratteristiche ambientali del luogo d'installazione del prodotto)
- una naturale tendenza a manifestare fessurazioni e crepe a causa di variazioni di volume dettate dalle variazioni climatiche/ambientali del luogo di installazione

Tali comportamenti sono dunque da considerarsi tipici e non costituiscono difetto nel prodotto.

Si ricorda però che una adeguata e frequente manutenzione degli elementi in legno, in base alla tipologia di legno scelta e alle condizioni ambientali del luogo di installazione, aiuta a preservarne la qualità e la durata, rallentando il fisiologico processo di invecchiamento del materiale.

WOOD

LEGNO

MADERA

BOIS

Bellitalia® ha seleccionado tres categorías de maderas para sus productos:

MADERA DURA (iroko, movingui u otras similares)

Bellitalia® se reserva la facultad de seleccionar en cada caso las maderas duras, más idóneas para las exigencias de producto y/o proyecto y/o en función de la disponibilidad del mercado.

La madera dura se suministra con un tratamiento de acabado pigmentado a base de agua, aunque se puede pedir que la madera se suministre sin el tratamiento de acabado. Bajo pedido, la madera dura está disponible también con la certificación FSC.

MADERA DE CONÍFERA (pino, abeto u otras similares)

Bellitalia® se reserva la facultad de seleccionar en cada caso el tipo de madera de conífera más idónea para las exigencias de producto y/o proyecto y/o en función de la disponibilidad del mercado. Bellitalia® utiliza madera de conífera laminada o maciza dependiendo de las características técnicas del producto.

La madera de conífera se suministra siempre con tratamiento de acabado, pigmentado a base de agua.

Bajo pedido, la madera de conífera está disponible también con la certificación FSC.

OKUME

Bellitalia® utiliza madera de okume multicapas o maciza dependiendo de las características técnicas del producto.

La madera de okume se suministra siempre con tratamiento de acabado pigmentado a base de agua y para productos específicos, los colores rojo y verde están disponible.

Consultar la página relativa del catálogo para saber cuál es el tipo de madera utilizada en cada producto.

NOTA: La madera es un material natural y, por ello, es normal que cambie de aspecto con el tiempo, sobre todo por:

- una tendencia natural a agrisarse, más o menos marcada y/o rápida en función del tipo de madera y/o de las características ambientales del lugar de instalación del producto
- una tendencia natural a la aparición de hendiduras y grietas por variaciones de volumen, debidas a cambios climáticos/ambientales del lugar de instalación

Por consiguiente, dichos comportamientos se han de considerar típicos y no son defectos del producto.

Sin embargo, se recuerda que un mantenimiento adecuado y frecuente de los elementos de madera, en función del tipo de madera elegido y de las condiciones ambientales del lugar de instalación, ayuda a conservar su calidad y duración, al ralentizar el proceso natural de envejecimiento del material.

Bellitalia® a sélectionné trois catégories de bois pour ses produits:

BOIS DUR (iroko, movingui ou similaire)

Bellitalia® se réserve de sélectionner au cas par cas les bois durs les mieux adaptés aux exigences du produit ou du projet ou en fonction des disponibilités du marché.

Le bois dur fourni reçoit un traitement de finition pigmenté à base d'eau, mais il est possible de demander à recevoir un bois sans traitement de finition. Sur demande, le bois dur est également disponible certifié FSC.

BOIS DE CONIFÈRES (pin, sapin ou similaire)

Bellitalia® se réserve de sélectionner au cas par cas les bois de conifères les mieux adaptés aux exigences du produit ou du projet ou en fonction des disponibilités du marché. En fonction des caractéristiques techniques du produit, Bellitalia® utilise du bois de conifères lamellaire ou massif.

Le bois de conifères fourni reçoit toujours un traitement de finition pigmenté à base d'eau.

Sur demande, le bois de conifères est également disponible certifié FSC.

OKUMÉ

En fonction des caractéristiques techniques du produit, Bellitalia® utilise du bois d'okumé stratifié ou massif.

Le bois d'okumé fourni reçoit toujours un traitement de finition pigmenté à base d'eau, et pour des produits spécifiques il y a le vert et le rouge disponibles.

Voir la page de catalogue correspondante pour en savoir plus sur le type de bois utilisé pour chaque produit.

Remarque: Étant donné que le bois est un matériau naturel, il est normal que son aspect change au fil du temps, principalement en raison des facteurs suivants:

- une tendance naturelle au grésillement, plus ou moins prononcée ou précoce, en fonction du type de bois ou des caractéristiques environnementales du lieu de pose du produit
- une tendance naturelle à présenter des fissures et des craquelures en raison de la variation de volume relevant des changements climatiques/environnementaux du lieu de pose

Ce type de réaction est donc à considérer comme typique et ne constitue pas un défaut du produit.

Rappelons toutefois qu'un entretien approprié et régulier des éléments en bois, adapté au type de bois choisi et aux conditions environnementales du lieu de pose, contribue à en préserver la qualité et la durabilité en ralentissant le processus de vieillissement naturel du matériau.







BELLITALIA

INSPIRED BY TIMELESS BEAUTY





DUNS NUMBER 428735856



24584/16/00



UNI EN ISO 9001:2015
(ISO 9001:2015)



FSC-STD-40-004 VER2.1

The mark of
responsible forestry



2015-SKM-PEFC-121

CERTIFICATIONS CERTIFICAZIONI

- ACCELERATING AGING RESISTANCE TEST
- PROVA DI RESISTENZA ALL'INVECCHIAMENTO ACCELERATO

- TRACTION RESISTANCE FOR METAL COMPONENTS TEST
- PROVA DI RESISTENZA A TRAZIONE MATERIALI METALLICI

- COMPRESSION TEST
- PROVA DI COMPRESSIONE

- DENSITY OF CURED CONCRETE MEASUREMENT
- MISURAZIONE DELLA DENSITÀ DEL CALCESTRUZZO INDURITO

- COMPRESSIVE STRENGTH RESISTANCE TEST
- TEST DI RESISTENZA ALLA COMPRESSIONE

- WATER PENETRATION DEPTH UNDER PRESSURE ON SAMPLES WBR-HTC
- TEST DI PROFONDITÀ DI PENETRAZIONE DELL'ACQUA SOTTO PRESSIONE SU PROVINI WBR-HTC

- SCRATCH RESISTANCE TEST - HARDNESS OF COATINGS
- TEST DI RESISTENZA AL GRAFFIO E DUREZZA DEI TRATTAMENTI SUPERFICIALI

- THERMIC SHOCK RESISTANCE TEST
- PROVA DI RESISTENZA ALLO SHOCK TERMICO

- ACCELERATING AGING RESISTANCE AWT 720 H FOR METAL COMPONENTS TEST
- PROVA DI RESISTENZA ALL'INVECCHIAMENTO ACCELERATO AWT 720 H PER MATERIALI METALLICI

- WEATHERING RESISTANCE TEST
- TEST DI RESISTENZA ALLE INTEMPERIE

- WEATHERING RESISTANCE TEST FOR COATINGS
- TEST DI RESISTENZA ALLE INTEMPERIE PER I TRATTAMENTI SUPERFICIALI

- GLOSS VALUE TEST AT 60°
- TEST BRILLANTEZZA A 60°

- CROSS-CUT RESISTANCE TEST
- TEST DI RESISTENZA ALLA QUADRETTATURA

- ABRASION RESISTANCE TEST
- TEST DI RESISTENZA ALL'ABRASIONE

Concept:
Marina Tasca

Pictures:
Archivio Bellitalia® | Bellitalia® Archive
Francesco Vascellari
Marina Tasca
Memento Comunicazione
Nicole Struppert
Jorge Moro
Pietro Savorelli
Per Kårehed
Comune di Milano - PH Andrea Scuratti

© Tutti i diritti riservati.
È vietata la riproduzione anche parziale di immagini e testi.
© All rights reserved.
The reproduction of images, drawings and texts, even if partial,
is forbidden.

Finito di stampare nel mese di Settembre 2022
Prima edizione

Printed in September 2022
First Edition

Bellitalia® Srl si riserva di apportare ai propri prodotti
qualsiasi modifica ritenuta utile al miglioramento qualitativo
degli stessi, sia dimensionale che strutturale.
Foto, disegni e testi non hanno carattere contrattuale.

Bellitalia® Srl reserves the right to modify the
dimensions and structure of its products at any time without
prior notice in order to improve quality and durability.
Photo, drawings and texts are not contractual.

Le immagini contenute in questo catalogo hanno solo lo scopo
illustrativo, per alcuni prodotti abbiamo utilizzato visualizzazioni.

The images contained in this catalogue are for illustrative
purposes only, for some products we used visualizations.

Per eventuali modifiche o aggiornamenti, fare riferimento al sito
web: www.bellitalia.net

For possible modifications or updates, please refer to the web
site: www.bellitalia.net



VIALE CADORE, 67
32014 PONTE NELLE ALPI (BL)
ITALY

T + 39 0437 990047
F + 39 0437 998839

www.bellitalia.net
info@bellitalia.net

Bellitalia® is part of
THE PLACEMAKERS S.r.l.